

# nepros

neXT	056
TOOL SET	068
SOCKETS AND DRIVE TOOLS	076
WRENCHS	120
PLIERS	130
SCREWDRIVERS	133



# The ultimate tool with strength, ease of use, and beauty.

nepros was born in 1995 after 5 years of development to achieve world's greatest tools.

Since then, we have continued to listen to the voices of professional mechanics and engineers to improve this brand based on the product concept of "stronger, better to use, and more beautiful".

\*"nepros" means New Professional Satisfaction.



#### RATCHET HANDLE

90 gears and precision 8-step claw for a more compact head. The lightweight handle reduce the work load.







**SOCKET**

The power-fit shape allows for more secure tightening and loosening by enlarging the contact surface. Minimized outer diameter, overall length, and depth. The world's most compact size.

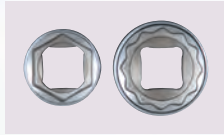

**HALF-MOON BOX END WRENCH**

Unique design with different curvatures, adapts to a wider range of work. The beauty of the hard chrome plating on the surface satisfies the sense of ownership.



**OPEN END WRENCH**

For better workability, designed with our own spear shape achieving compactness and strength.



**SCREWDRIVER**

The unique streamlined wood pattern with a hexagonal cross-sectional shape. Best hand fit grip and excellent power transmission.



**BOX END WRENCH**

To maximize the contact area with the bolt/nut. Minimized taper design.



**PLIERS**

Soft grip provides stability in grasping, cutting, and turning.



nepros

---

neXT



neXT TOOL SET [70pcs.]

3/8" sq.

70 pcs.



1st drawer

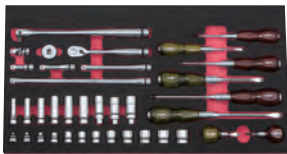

2nd drawer

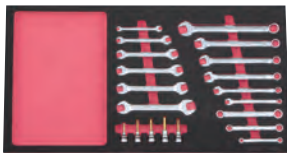

3rd drawer



NTX1WA70AT2



No.	Number of tools	Weight(kg)
NTX1WA70A	70	41
Set contents		
NTX1WA70AT	Assembly and trays	× 1
NEKT-W2013	Wide base (3 stages, 3 drawers)	× 1
* Picture is for illustrative purposes only. Do not open multiple drawers at the same time. Packing unit 1 (2 units)		
Contents		
3/8"sq. socket (6pt.)	NB3-055,07,08,10,12,13,14,17,19,21,22,24	
3/8"sq. deep socket (6pt.)	NB3L-08,10,12,13,14,17	
3/8"sq. plug wrench	NB3-16SP,18SP,20SP	
3/8"sq. ratchet handle	NBR390A	
3/8"sq. Breaker bar	NBS3	
3/8"sq. extension bar	NBE3-050,075,150,300	
3/8"sq. quick spinner	NBE38	
3/8"sq. universal joint	NBJ3	
3/8"sq. hexagonal bit socket	NBT3-04,05,06,08	
3/8"sq. cross bit socket	NBT3P-2	
45° × 6° box end wrench	NM5-0810,1012,1113,1214,1417,1719,1921,2224	
Flat type box end wrench (short)	NM15-0708,1012,1214	
Combination wrenches	NMS2-08,10,12,13,14,17	
Open end wrench	NS2-05507,0810,1012,1113,1214,1417	
Pliers	NPJ-200	
Adjustable wrench	NWM-250	
Longnose pliers	NPSL-200	
Angle nose pliers	NPSL-200BN	
Wide Nippers	NPN-150BW	
Wooden grip screwdriver (stubby flat)	ND3M-055,06,08	
Wooden grip screwdriver (stubby cross)	ND3P-1,2,3	
Wooden grip screwdriver (stubby flat)	ND3MS-06	
Wooden grip screwdriver (stubby cross)	ND3PS-2	

Spare parts

No.	Description	Weight(kg)
NTX1WA70AT2	Tray	1

Packing unit 1

neXT TOOL SET [42pcs.]

3/8" sq.

42 pcs.



1st drawer



2nd drawer

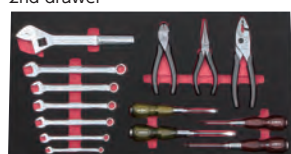

NTX1WA42AT2



No.	Number of tools	Weight(kg)
NTX1WA42A	42	36
Set contents		
NTX1WA42AT	Assembly and trays	× 1
NEKT-W2013	Wide base (3 stages, 3 drawers)	× 1
* Picture is for illustrative purposes only. Do not open multiple drawers at the same time. Packing unit 1 (2 units)		
Contents		
3/8"sq. socket (6pt.)	NB3-055,07,08,10,12,13,14,17,19,21,22	
3/8"sq. deep socket (6pt.)	NB3L-08,10,12,13,14	
3/8"sq. hexagonal bit socket	NBT3-04,05,06,08	
3/8"sq. cross bit socket	NBT3P-2	
3/8"sq. ratchet handle	NBR390A	
3/8"sq. Breaker bar	NBS3	
3/8"sq. extension bar	NBE3-050,075,150	
3/8"sq. quick spinner	NBE38	
3/8"sq. universal joint	NBJ3	
Combination wrenches	NMS2-08,10,12,13,14,17	
Adjustable wrench	NWM-250	
Pliers	NPJ-200	
Radio pliers	NPSL-150	
Wide Nippers	NPN-150BW	
Wooden grip screwdriver (stubby flat)	ND3M-055,06	
Wooden grip screwdriver (stubby cross)	ND3P-1,2	

Spare parts

No.	Description	Weight(kg)
NTX1WA42AT2	Tray	0.7

Packing unit 1

• Function mark is indicated under the product name. For the details, please refer to P.004-005.  
• Products marked with ⚠ should be ordered after checking stock.



**neXT TOOL SET [27pcs.]**

3/8" sq.

27 pcs.



NTX1WB27AT2



No.	Number of tools	Weight(kg)	
NTX1WB27A	27	21.5	
Set contents			
NTX1WB27AT	Assembly and trays	× 1	
NEKT-W2111	Wide first (2 stages, 1 drawer)	× 1	
Packing unit 1 (2 units)			
Contents			
3/8"sq. socket (6pt.)	NB3-08,10,12,13,14,17,19		
3/8"sq. ratchet handle	NBR390A		
3/8"sq. Breaker bar	NBS3		
3/8"sq. extension bar	NBE3-075,150		
3/8"sq. quick spinner	NBE38		
3/8"sq. universal joint	NBJ3		
Combination wrenches	NMS2-08,10,12,13,14,17		
Adjustable wrench	NWM-250		
Pliers	NPJ-200		
Radio pliers	NPSL-150		
Wide Nippers	NPN-150BW		
Wooden grip screwdriver (stubby flat)	ND3M-055,06		
Wooden grip screwdriver (stubby cross)	ND3P-1,2		

**Spare parts**

No.	Description	Weight(g)	
NTX1WB27AT2	Tray	500	

Packing unit 1

**neXT TOOL SET [27pcs.]**

3/8" sq.

27 pcs.

1st drawer



2nd drawer



3rd drawer



NTX1NA27AT2



No.	Number of tools	Weight(kg)	
NTX1NA27A	27	26	
Set contents			
NTX1NA27AT	Assembly and trays	× 1	
NEKT-N2012	Narrow base (3 stages, 2 drawers)	× 1	
* Picture is for illustrative purposes only. Do not open multiple drawers at the same time.			
Packing unit 1 (2 units)			
Contents			
3/8"sq. socket (6pt.)	NB3-08,10,12,13,14,17,19		
3/8"sq. ratchet handle	NBR390A		
3/8"sq. Breaker bar	NBS3		
3/8"sq. extension bar	NBE3-075,150		
3/8"sq. quick spinner	NBE38		
3/8"sq. universal joint	NBJ3		
Combination wrenches	NMS2-08,10,12,13,14,17		
Adjustable wrench	NWM-250		
Pliers	NPJ-200		
Radio pliers	NPSL-150		
Wide Nippers	NPN-150BW		
Wooden grip screwdriver (stubby flat)	ND3M-055,06		
Wooden grip screwdriver (stubby cross)	ND3P-1,2		

**Spare parts**

No.	Description	Weight(g)	
NTX1NA27AT2	Tray	500	

Packing unit 1

• Do not disassemble or modify the product.

**neXT STORAGE WIDE  
(3 STAGES, 3 DRAWERS)**



No.	Weight(kg)
NEKT-W2013	31.5

Drawer	Internal dimensions w610×d310×h60mm×3 shelves (load capacity 5kg)
Accessory	Drawer mat×3

· This is the neXT basic unit with 3 drawers.  
\* Tools are not included.  
Packing unit 1

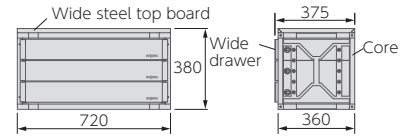

**neXT STORAGE WIDE  
(2 STAGES, 1 DRAWER)**



No.	Weight(kg)
NEKT-W2011	18

Drawer	Internal dimensions w610×d310×h60mm×1 section (load capacity 5kg)
Tray	Internal dimensions w660×d345×h70mm×1 section (load capacity 15kg)
Accessory	Drawer mat×3, Bolt and nut set (for connection)

· This expansion unit can be connected under NEKT-W2013 and NEKT-W2111.  
\* Tools are not included.  
Packing unit 1

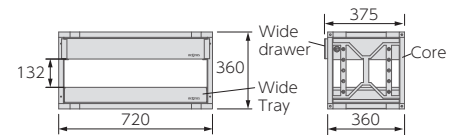

**neXT STORAGE WIDE  
(2 STAGES, 1 DRAWER)**



No.	Weight(kg)
NEKT-W2111	18

Stage	w645×d355mm×1 level (load capacity 5kg)
Drawer	Internal dimensions w610×d310×h60mm×1 section (load capacity 5kg)
Accessory	Drawer mat×3

· Entry unit with one drawer and a shelf that can adjust angle.  
\* Tools are not included.  
Packing unit 1

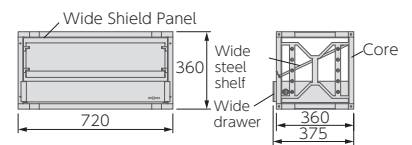

**neXT STORAGE NARROW  
(3 STAGES, 2 DRAWERS)**



No.	Weight(kg)
NEKT-N2012	23

Drawer	Internal dimensions w250×d310×h60mm×2 sections (load capacity 3kg)
Tray	Internal dimensions w300×d345×h70mm×1 section (load capacity 7.5kg)
Accessory	Drawer mat×3

· Narrow type with core frame placed vertically.  
\* Tools are not included.  
Packing unit 1

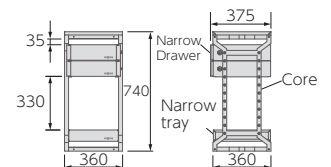

· Function mark is indicated under the product name. For the details, please refer to P.004-005.  
· Products marked with should be ordered after checking stock.





neXT ACCESSORIES FRAME CORE

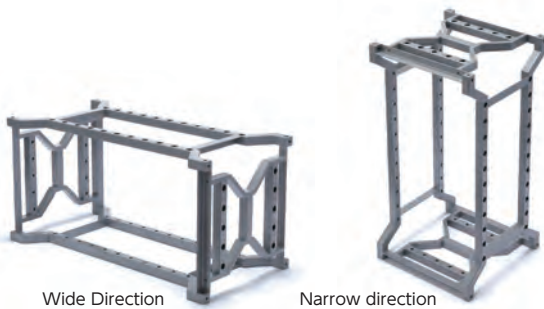

No.		Weight(kg)	
NEKC-CR	When using in the wide direction W720×D360×H360 When used in the narrow direction W360×D360×H720	8.3	

Accessory	neXT emblem (NEKC-EM)
-----------	-----------------------

- The latest structural optimization method, topology analysis, has been achieved high rigidity, light weight, and high design quality. Available in both wide (horizontal) and narrow (vertical) directions.
- By using extension A (bolts for connection), it is possible to stack them up for use in the wide direction. The modules are connected to each other with screws, which makes assembly and expansion easy.

Packing unit 1

neXT ACCESSORIES EMBLEM



No.		Weight(g)	
NEKC-EM	92×33×3	10	

- The tape can be affixed anywhere you like. The recommended position is on the front of the drawer.

- The metal is plated and painted to give it a high-grade appearance.

Packing unit 1

neXT ACCESSORIES EXTENSION SET



No.		Weight(g)	
NEKC-EXA	Hexagon socket bolt M8×L60 ×4 Hexagonal nut with washer M8 ×4 Flat washer Nominal 8 ×4	180	

- These bolts are required when stacking and connecting cores in the wide direction.

Packing unit 1

neXT ACCESSORIES WIDE TOPBOARD (STEEL)



No.		Weight(kg)	
NEKW-ST	720×360×20	4.1	

Accessory	Screw M6×L35	×6
-----------	--------------	----

- The top surface can be used as a desk or workbench.

Packing unit 1

neXT ACCESSORIES WIDE TOPBOARD (WOOD)



No.		Weight(kg)	
NEKW-WT	720×360×20	4	

Accessory	Screw M6×L35	×6
-----------	--------------	----

- The top surface can be used as a desk or workbench.

Packing unit 1

neXT ACCESSORIES WIDE PANEL



No.		Weight(g)	
NEKW-SP	665×355×3	800	
Accessory	Compact screw M6×L40		×6
	Compact screw M6×L16		×10
	Hexagonal nut with washer and metal washer M6		×10

• A translucent top board that you can see what is stored in drawers and shelves.  
Packing unit 1

neXT ACCESSORIES WIDE DRAWER



No.		Weight(kg)	
NEKW-DR	Interior dimensions W612×D311×H60	6.4	
Accessory	Screw M6×L8		×4

• Drawer handles are placed on both sides to allow natural access by a person standing in front of the case. Drawers can be easily opened and closed from the side of the case.  
Packing unit 1

neXT ACCESSORIES WIDE DRAWER (DEEP)



No.		Weight(kg)	
NEKW-DDR	W612×D311×H160	10	
Accessory	Screw M6×L8		×8

• Drawer handles are placed on both sides to allow natural access by a person standing in front of the case. Drawers can be easily opened and closed from the side of the case.  
Packing unit 1

neXT ACCESSORIES WIDE PANEL (REAR)



No.		Weight(g)	
NEKW-DRRP	W649×D37×H99	600	
Accessory	Tapping screw 4×L8		×4

• This panel can be used to conceal the back of the drawer.  
Packing unit 1

neXT ACCESSORIES WIDE PANEL (REAR, DEEP)



No.		Weight(kg)	
NEKW-DDRRP	W649×D37×H199	1	
Accessory	Tapping screw 4×L8		×4

• This panel can be used to conceal the back of the drawer.  
Packing unit 1

• Function mark is indicated under the product name. For the details, please refer to P.004-005.  
• Products marked with  should be ordered after checking stock.



**neXT ACCESSORIES WIDE TRAY**



No.		Weight(kg)
NEKW-TR	Interior dimensions W663×D349×H69	3.2
Accessory	Screw M6×L8 ×4 Hexagonal bolt M6 ×4	

• Fixed tray.  
Packing unit 1

**neXT ACCESSORIES WIDE SHELFBOARD (STEEL)**



No.		Weight(kg)
NEKW-SS	Inside Dimensions W647×D359×L-shaped receptacle H34 Thickness 10	2.7
Accessory	Screw M6×L8 ×4 Plate Support ×4	

• The stored items are visible from the outside and can be used for display. It can be mounted horizontally as well as at an angle.  
Packing unit 1

**neXT ACCESSORIES WIDE SHELFBOARD (WOOD)**



No.		Weight(kg)
NEKW-WS	Inside Dimensions W647×D359×L-shaped receptacle H34 Thickness 10	2.2
Accessory	Screw M6×L8 ×4 Plate Support ×4	

• The stored items are visible from the outside and can be used for display. It can be mounted horizontally as well as at an angle.  
Packing unit 1

**neXT ACCESSORIES WIDE SHELFBOARD (GLASS)**

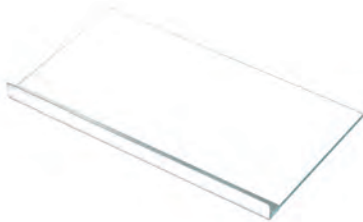

No.		Weight(kg)
NEKW-GS	Dimensions W647×D359×L-shaped receptacle H34, thickness 8	5.1
Accessory	Screw M6×L8 ×4 Plate Support ×4	

• The stored items are visible from the outside and can be used for display. It can be mounted horizontally as well as at an angle.  
Packing unit 1

**neXT ACCESSORIES NARROW TOPBOARD (STEEL)**



No.		Weight(kg)
NEKN-ST	360×360×20	2.1
Accessory	Screw M6×L35 ×4	

• The top surface can be used as a desk or workbench.  
Packing unit 1

• Do not disassemble or modify the product.



neXT ACCESSORIES NARROW TOPBOARD (WOOD)



No.		Weight(kg)	
NEKN-WT	360×360×20	2	
Accessory	Screw M6×L35	×4	

· The top surface can be used as a desk or workbench.  
Packing unit 1

neXT ACCESSORIES NARROW PANEL



No.		Weight(g)	
NEKN-SP	305×355×3	400	
Accessory	Spacer	×6	
	Head screw M6×L16	×6	
	Head screw M6×L40	×6	
	Head screw M6×L70	×4	
	Hexagonal nut with washer and metal washer M6	×6	

· A translucent top board that you can see what is stored in drawers and shelves.  
Packing unit 1

neXT ACCESSORIES NARROW DRAWER



No.		Weight(kg)	
NEKN-DR	Inside dimensions W252×D311×H60	5.2	
Accessory	Screw M6×L8	×4	

· Drawer handles are placed on both sides to allow natural access by a person standing in front of the case. Drawers can be easily opened and closed from the side of the case.  
Packing unit 1

neXT ACCESSORIES NARROW DRAWER (DEEP)



No.		Weight(kg)	
NEKN-DDR	Inside dimensions W252×D311×H160	8.1	
Accessory	Screw M6×L8	×8	

· Drawer handles are placed on both sides to allow natural access by a person standing in front of the case. Drawers can be easily opened and closed from the side of the case.  
Packing unit 1

neXT ACCESSORIES NARROW PANEL (REAR)



No.		Weight(g)	
NEKN-DRRP	W289×D37×H99	300	
Accessory	Tapping screw size 4×L8	×4	

· This panel can be used to conceal the back of the drawer.  
Packing unit 1

· Function mark is indicated under the product name. For the details, please refer to P.004-005.  
· Products marked with  should be ordered after checking stock.



**neXT ACCESSORIES NARROW PANEL  
(REAR, DEEP)**



No.		Weight(g)	
NEKN-DDRRP	W289×D37×H199	500	
Accessory	Tapping screw size 4×L8	×4	

· This panel can be used to conceal the back of the drawer.  
Packing unit 1

**neXT ACCESSORIES  
NARROW TRAY**



No.		Weight(kg)	
NEKN-TR	Interior dimensions W303×D349×H69	1.8	
Accessory	Screw M6×L8	×4	
	Hexagonal bolt M6	×4	

· Fixed tray.  
Packing unit 1

**neXT ACCESSORIES  
NARROW SHELFBOARD (STEEL)**

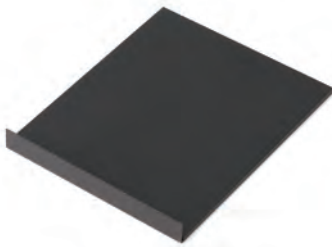

No.		Weight(kg)	
NEKN-SS	Inside Dimensions W287×D359×L-shaped receptacle H34 Thickness 10	1.2	
Accessory	Screw M6×L8	×4	
	Plate Support	×4	

· The stored items are visible from the outside and can be used for display. It can be mounted horizontally as well as at an angle.  
Packing unit 1

**neXT ACCESSORIES NARROW SHELFBOARD  
(WOOD)**



No.		Weight(kg)	
NEKN-WS	Inside Dimensions W287×D359×L-shaped receptacle H34 Thickness 10	1.1	
Accessory	Screw M6×L8	×4	
	Plate Support	×4	

· The stored items are visible from the outside and can be used for display. It can be mounted horizontally as well as at an angle.  
Packing unit 1

**neXT ACCESSORIES NARROW SHELFBOARD  
(GLASS)**

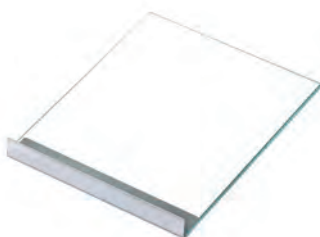

No.		Weight(kg)	
NEKN-GS	Inside Dimensions W287×D359×L-shaped receptacle H34 Thickness 8	2.3	
Accessory	Screw M6×L8	×4	
	Plate Support	×4	

· The stored items are visible from the outside and can be used for display. It can be mounted horizontally as well as at an angle.  
Packing unit 1

## neXT ACCESSORIES ADJUSTER



No.	Contents	Weight(g)	
NEKC-HA	Main body×4 nut M8×8	200	

- The height can be adjusted according to the mounting position of the accessory nut.
- Easy installation by direct attachment to the end of the core.
- Direction of core use: Can be assembled to either wide or narrow cores.

## neXT ACCESSORIES CASTER (SMALL)



No.	Contents	Weight(g)	
NEKC-SCA	With lock×2, without lock×2, nut M8×4, washer×4	600	

- $\Phi 50$  casters made of soft resin to prevent damage to floor surfaces.
- All four wheels are on free-swivel casters, which are advantageous for moving in tight spaces.
- Two of the four wheels have locks. (Only wheels are locked).
- Easy installation by assembling to the end via a reinforcement plate.
- Can be assembled in either wide or narrow direction. (Up to 2 core layers in the wide direction and only 1 core layer in the narrow direction)
- \* Indoor use only (For outdoor use, use large caster NEKC-LCA.)

## neXT ACCESSORIES CASTER (LARGE)



No.	Contents	Weight(g)	
NEKC-LCA	With lock×2, without lock×2, nut M8×4, washer×4	1,300	

- $\Phi 100$  casters made of soft resin to prevent damage to floor surfaces.
- All four wheels are on free-swivel casters, which are advantageous for moving in tight spaces.
- The four wheels and two of the four wheels are equipped with locks.
- The lock locks the rotation of the wheel and the turning of the axle at the same time. (Two-way lock)
- Easy installation by assembling to the end via a reinforcement plate.
- Can be assembled in either wide or narrow direction. (Up to 3 core layers in the wide direction and only 1 core layer in the narrow direction)
- \* For indoor/outdoor use (not for use on unpaved roads)



1/4"sq. WALNUT TOOL SET [29pcs.]

1/4" sq.

29 pcs.



1st drawer



2nd drawer



No.	Number of tools	Weight(kg)	
NTX929W	29	15.4	
Set contents			
NTX929WT	Assembly		× 1
NEKR-104W	Chest of drawers Walnut (4 stages, 3 drawers)		× 1
Packing unit 1 (2 units)			
Contents			
1/4"sq. socket (6pt.)		NB2-08,10,12,13,14	
1/4"sq. hexagon bit socket		NBT2-02,025,03,04,05,06	
1/4"sq. ratchet handle		NBR290	
1/4"sq. breaker bar (short)		NBS2S	
1/4"sq. extension bar		NBE2-050,075	
Wooden grip screwdriver (stubby flat)		ND3M-06	
Wooden grip screwdriver (stubby cross)		ND3P-1,2	
Wooden grip screwdriver (stubby flat)		ND3MS-06	
Wooden grip screwdriver (stubby cross)		ND3PS-2	
Combination wrenches		NMS2-08,10,12,13,14	
Adjustable wrench		NWM-250	
Nippers		NPN-150	
Radio pliers		NPSL-150	
Pliers		NPJ-150	

3/8"sq. WALNUT URUSHI RATCHET HANDLE SET [7pcs.]

3/8" sq.

7 pcs.



OMOTENASHI SELECTION 2021

No.	Number of tools	Weight(kg)	
NTX907JWA	7	14.1	
Set contents			
NTX907JWAT	Assembly		× 1
NEKR-104W	Chest of drawers Walnut (4 stages, 3 drawers)		× 1
* Lacquer ratchet handle sets are made to order.			
Packing unit 1 (2 units)			
Contents			
YANAGI		NBR390AJYA	
RYUMON KARAKUSA		NBR390AJKAR	
ICHIMATSU		NBR390AJCHE	
ROUKI		NBR390AJKAM	
ZUIUN		NBR390AJZU	
GENJI KURUMA		NBR390AJGE	
TAKI		NBR390AJTA	

WALNUT CHEST (4STAGES, 3DRAWERS)



Partition board



Small tray



OMOTENASHI SELECTION 2021

No.	Weight(kg)	
NEKR-104W	11	
Main body	W552×D325×H382 (Load capacity 20kg *Top board)	
Small drawer	w106×d162×h22 (Load capacity 1kg)	
Movable tray	w429×d290.5×h25~35 (Load capacity 5kg)	
Drawer top and bottom	w400×d246×h52 (Load capacity 5kg)	
Accessory	Partition board×6, Small tray	
· The walnut is a high-grade material that fits in well with living rooms and other spaces. It is also suitable as a material for tool boxes because of its high impact resistance and minimal deviation after drying.		
Packing unit 1		

The OMOTENASHI Selection is an award established in 2015 with the aim of discovering and spreading excellent Japanese products and services with a spirit of "Omotenashi" to the world.

· Do not disassemble or modify the product.

3/8"sq. URUSHI RATCHET HANDLE

- 
- 
- 
- Repair
- Spare parts
- Repairable



NBR390AJYA

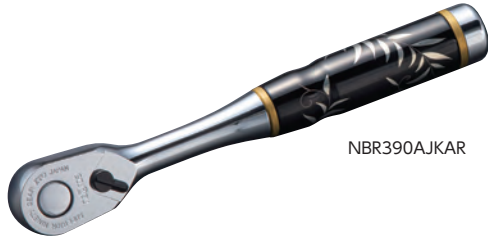

NBR390AJKAR

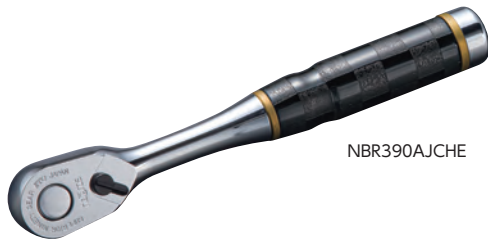

NBR390AJCHE



NBR390AJKAM



NBR390AJZU



NBR390AJGE



NBR390AJTA

No.	Design	Feed angle	B	φ	T	L	Weight(g)
NBR390AJYA	YANAGI	4°	26	20	14	180	245
NBR390AJKAR	RYUMON KARAKUSA	4°	26	20	14	180	245
NBR390AJCHE	ICHIMATSU	4°	26	20	14	180	245
NBR390AJKAM	ROUKI	4°	26	20	14	180	245
NBR390AJZU	ZUIUN	4°	26	20	14	180	245
NBR390AJGE	GENJI KURUMA	4°	26	20	14	180	245
NBR390AJTA	TAKI	4°	26	20	14	180	245

- The grip of the NBR390A (P.107), which has been deepened into a more user-friendly ratchet handle by downsizing the head, reducing the weight, and optimizing the balance, is covered with "Urushi lacquer", known as JAPAN traditional technique.
- The transparency of the lacquer increases with age. You can enjoy this change as well.
- This is an ornamental art tool that combines functional beauty and traditional beauty. It can also be used as an ordinary tool.

\* This product is made-to-order. It takes approximately one to three months to ship after an order is placed. (This will vary depending on the product and quantity.)

\* Repair kit (NBR390A-K) is available.

\* Repair parts are set. Refer to "Repairable List" from P.625.

Packing unit 1



• To avoid damage or idling, be sure to operate the left and right switching levers securely.

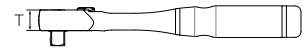
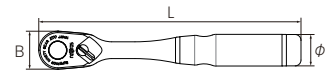

nePROS

URUSHI Ratchet Handle

Functional beauty × Traditional beauty  
The ultimate fusion of Kyoto aesthetics.

nepros, the world's top hand tool manufacturer, has created a completely made-to-order model clad in "Urushi", also known as "Japan" traditional technique. The new horizon of "functional beauty × traditional beauty" has been opened up by the combination of "advanced technology" of solid quality and "gorgeous traditional decoration". The NBR390A ratchet handle head is the first evolution in 10 years of the gem that was displayed as a reference exhibit at COOL KYOYO 2011 and attracted much attention. Please enjoy the fusion of Kyoto's traditional techniques and KTC's most beautiful tools.

Traditional technique



Tools and lacquer. Practical use and appreciation. The seemingly contradictory values are connected to the "Kyoto aesthetic sense". Throughout history, lacquer has been used to add color to many tools and to bring pleasure to people. The seven designs on the nepros lacquer ratchet handles were chosen as the lineage of this tradition, and are drawn one by one using a very authentic traditional technique.

Manufacturing Process



The beautiful form of nepros has captured the hearts of lacquer masters who are bringing the traditions of Kyoto to the present day. Sato Kiyomatsu Shoten is an expert in lacquer, and at the same time, a challenger who tries to give lacquer new value.

• Function mark is indicated under the product name. For the details, please refer to P.004-005.  
• Products marked with should be ordered after checking stock.



nepros

---

## TOOL SET

3/8"sq. TOOL SET [77pcs.]

-  3/8" sq.
-  77 pcs.
-  90



NTX10770BK



NTX10770R



NTX10770S



NTX10770WH

1st drawer

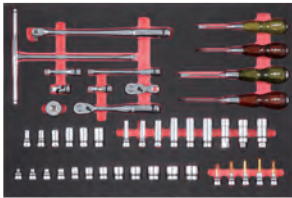

2nd drawer

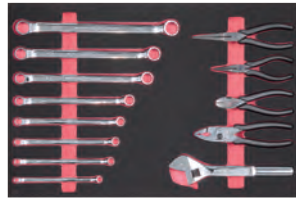

3rd drawer

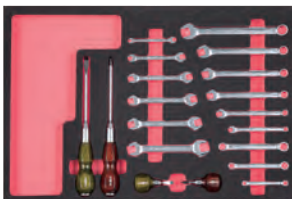

NTX10770ST2



No.	Number of tools	Weight(kg)
NTX10770R	77	91

Set contents		
NTX10770ST	Assembly and trays	× 1
EKW-1007R	Roller cabinet (7 stages, 7 drawers)	× 1 (W740×D470×H910)

Packing unit 1 (2 units)

No.	Number of tools	Weight(kg)
NTX10770BK	77	91

Set contents		
NTX10770ST	Assembly and trays	× 1
EKW-1007BK	Roller cabinet (7 stages, 7 drawers)	× 1 (W740×D470×H910)

Packing unit 1 (2 units)

No.	Number of tools	Weight(kg)
NTX10770S	77	91

Set contents		
NTX10770ST	Assembly and trays	× 1
EKW-1007	Roller cabinet (7 stages, 7 drawers)	× 1 (W740×D470×H910)

Packing unit 1 (2 units)

No.	Number of tools	Weight(kg)
NTX10770WH	77	91

Set contents		
NTX10770ST	Assembly and trays	× 1
EKW-1007WH	Roller cabinet (7 stages, 7 drawers)	× 1 (W740×D470×H910)

Packing unit 1 (2 units)

\* The NTX10770R, NTX10770BK, NTX10770S, and NTX10770WH all share the same set of components.

Contents	
3/8"sq. socket (6pt.)	NB3-055,07,08,10,12,13,14,17, 19,21,22,24
3/8"sq. semi-deep socket (6pt.)	NB3M-08,10,12,13,14,17
3/8"sq. deep socket (6pt.)	NB3L-08,10,12,13,14,17
3/8"sq. hexagonal bit socket	NBT3-04, 05, 06, 08
3/8"sq. cross bit socket	NBT3P-2
3/8"sq. plug wrench	NB3-16SP,18SP,208SP
3/8"sq. ratchet handle	NBR390A
3/8"sq. stubby ratchet handle	NBR390AH
3/8"sq. Breaker bar	NBS3
3/8"sq. T-type handle	NBHT3
3/8"sq. extension bar	NBE3-050,075,150
3/8"sq. quick spinner	NBE38
3/8"sq. universal joint	NBJ3
45° × 6° box end wrench	NM5-0810,1012,1113,1214,1417, 1719,1921,2224
Combination wrenches	NMS2-08,10,12,13,14,17
Flat type box end wrench (short)	NM1S-0708,1012,1214
Adjustable wrench	NWM-250
Open end wrench	NS2-05507,0810,1012,1113,1214, 1417
Pliers	NPJ-200
Radio pliers	NPSL-150
Longnose pliers	NPSL-200
Wide Nippers	NPN-150BW
Wooden grip screwdriver (stubby flat)	ND3M-055,06,08
Wooden grip screwdriver (stubby cross)	ND3P-1,2,3
Wooden grip screwdriver (stubby flat)	ND3MS-06
Wooden grip screwdriver (stubby cross)	ND3PS-2

· This is a top quality nepros tool set with a full set of tools to satisfy your needs.

· The case is the next-generation EKR-1007 roller cabinet, available in red, black, silver, and white color variation models.

Spare parts

No.	Description	Weight(kg)
NTX10770ST2	Tray	2.5

Packing unit 1

· Function mark is indicated under the product name. For the details, please refer to P.004-005.  
 · Products marked with  should be ordered after checking stock.





**3/8"sq. TOOL SET [77pcs.]**

3/8" sq.

77 pcs.

90

nepros

TOOL SET



NTX8770BK



NTX8770R



NTX8770S



NTX8770WH

Top part

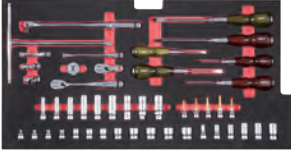

1st drawer



2nd drawer

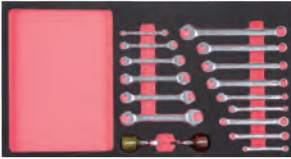

NTX8770ST2



No.	Number of tools	Weight(kg)	
NTX8770R	77	48	

Set contents			
NTX8770ST	Assembly and trays	× 1	
EKR-1004R	Top chest (4 stages, 4 drawers)	× 1 (W715×D390×H410)	

Packing unit 1 (2 units)

No.	Number of tools	Weight(kg)	
NTX8770BK	77	48	

Set contents			
NTX8770ST	Assembly and trays	× 1	
EKR-1004BK	Top chest (4 stages, 4 drawers)	× 1 (W715×D390×H410)	

Packing unit 1 (2 units)

No.	Number of tools	Weight(kg)	
NTX8770S	77	48	

Set contents			
NTX8770ST	Assembly and trays	× 1	
EKR-1004	Top chest (4 stages, 4 drawers)	× 1 (W715×D390×H410)	

Packing unit 1 (2 units)

No.	Number of tools	Weight(kg)	
NTX8770WH	77	48	

Set contents			
NTX8770ST	Assembly and trays	× 1	
EKR-1004WH	Top chest (4 stages, 4 drawers)	× 1 (W715×D390×H410)	

Packing unit 1 (2 units)

\* The NTX8770R, NTX8770BK, NTX8770S, and NTX8770WH all share the same set of components.

Contents	
3/8"sq. socket (6pt.)	NB3-055,07,08,10,12,13,14,17, 19,21,22,24
3/8"sq. semi-deep socket (6pt.)	NB3M-08,10,12,13,14,17
3/8"sq. deep socket (6pt.)	NB3L-08,10,12,13,14,17
3/8"sq. hexagonal bit socket	NBT3-04, 05, 06, 08
3/8"sq. cross bit socket	NBT3P-2
3/8"sq. plug wrench	NB3-16SP,18SP,208SP
3/8"sq. ratchet handle	NBR390A
3/8"sq. stubby ratchet handle	NBR390AH
3/8"sq. Breaker bar	NBS3
3/8"sq. T-type handle	NBHT3
3/8"sq. extension bar	NBE3-050,075,150
3/8"sq. quick spinner	NBE38
3/8"sq. universal joint	NBJ3
45° × 6° box end wrench	NM5-0810,1012,1113,1214,1417, 1719,1921,2224
Combination wrenches	NMS2-08,10,12,13,14,17
Flat type box end wrench (short)	NM1S-0708,1012,1214
Adjustable wrench	NWM-250
Open end wrench	NS2-05507,0810,1012,1113,1214, 1417
Pliers	NPJ-200
Radio pliers	NPSL-150
Longnose pliers	NPSL-200
Wide Nippers	NPN-150BW
Wooden grip screwdriver (stubby flat)	ND3M-055,06,08
Wooden grip screwdriver (stubby cross)	ND3P-1,2,3
Wooden grip screwdriver (stubby flat)	ND3MS-06
Wooden grip screwdriver (stubby cross)	ND3PS-2

- This is a top quality nepros tool set with a full set of tools to satisfy your needs.
- The case is the next-generation EKR-1004 chest, available in red, black, silver, and white color variations.

**Spare parts**

No.	Description	Weight(kg)	
NTX8770ST2	Tray	2.5	

Packing unit 1

• Do not use hand tools with an impact wrench.



3/8"sq. TOOL SET [60pcs.]



Top part



1st drawer



2nd drawer



3rd drawer



NTX759CT2



No.	Number of tools	Weight(kg)
NTX759C	60	19.5
Set contents		
NTX759CT	Assembly and trays	×1
EKR-103NB	Chest	×1 (W510×D275×H325)
Packing unit 1 (2 units)		
Contents		
3/8"sq. socket (6pt.)	NB3-055,07,08,10,12,13,14,17,19,21,22	
3/8"sq. semi-deep socket (6pt.)	NB3M-08,10,12,13,14	
3/8"sq. deep socket (6pt.)	NB3L-08,10,12,13,14	
3/8"sq. universal socket	NB3-08JU,10JU,12JU	
3/8"sq. hexagonal bit socket	NBT3-04,05,06,08	
3/8"sq. cross bit socket	NBT3P-2	
3/8"sq. ratchet handle	NBR390A	
3/8"sq. Breaker bar	NBS3	
3/8"sq. extension bar	NBE3-050,075,150	
3/8"sq. quick spinner	NBE38	
3/8"sq. universal joint	NB3J	
45° ×6" box end wrench	NMS-0810,1012,1113,1214,1417,1719	
Combination wrenches	NMS2-08,10,12,13,14,17	
Adjustable wrench	NWM-250	
Pliers	NPJ-200	
Radio pliers	NPSL-150	
Wide Nippers	NPN-150BW	
Wooden grip screwdriver (stubby flat)	ND3M-055,06,08	
Wooden grip screwdriver (stubby cross)	ND3P-1,2,3	
Wooden grip screwdriver (stubby flat)	ND3MS-06	
Wooden grip screwdriver (stubby cross)	ND3PS-2	
3/8"sq. socket holder	NEHB310 (3 pcs)	

- A well-stocked nepros tool set.
- The case is the next-generation chest "EKR-103A" in a color exclusive to nepros.
- \* 3/8"sq. socket holder is not included.

Spare parts

No.	Description	Weight(g)
NTX759CT2	Tray	500

Packing unit 1

CHEST (3 STAGES, 3 DRAWERS)



Foldable side table for small items.

No.	Weight(kg)
EKR-103NB	13
Body size	W510×D275×H325
Top part	w445×d225×h75 Load capacity 8.5kg
Drawer (1st to 2nd drawer) (3rd drawer)	w420×d215×h45 Load capacity 5kg w420×d215×h75 Load capacity 8.5kg
Side table×2	w160×d150 Load capacity 2kg
Top mat×1 Drawer mat×3	

- All drawers can be locked when all drawers are closed and the lids are closed.
- Foldable side table for small items.
- Can be locked with a padlock (sold separately).
- \* We do not sell individual cases.

• Function mark is indicated under the product name. For the details, please refer to P.004-005.  
• Products marked with ⚠ should be ordered after checking stock.



3/8"sq. TOOL SET [42pcs.]

3/8" sq.

42 pcs.

90



Top part



1st drawer



2nd drawer



3rd drawer

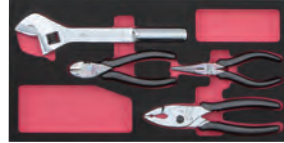

NTX759CT2



No.	Number of tools	Weight(kg)	
NTX740C	42	17.5	

Set contents	
NTX740CT	Assembly and trays ×1
EKR-103NB	Chest ×1 (W510×D275×H325)

Packing unit 1 (2 units)	
Contents	
3/8"sq. socket (6pt.)	NB3-055,07,08,10,12,13,14,17,19,21,22
3/8"sq. deep socket (6pt.)	NB3L-08,10,12,13,14
3/8"sq. hexagonal bit socket	NBT3-04,05,06,08
3/8"sq. cross bit socket	NBT3P-2
3/8"sq. ratchet handle	NBR390A
3/8"sq. Breaker bar	NBS3
3/8"sq. extension bar	NBE3-050,075,150
3/8"sq. quick spinner	NBE38
3/8"sq. universal joint	NBJ3
Combination wrenches	NMS2-08,10,12,13,14,17
Adjustable wrench	NWM-250
Pliers	NPJ-200
Radio pliers	NPSL-150
Wide Nippers	NPN-150BW
Wooden grip screwdriver (stubby flat)	ND3M-055,06
Wooden grip screwdriver (stubby cross)	ND3P-1,2
3/8"sq. socket holder	NEHB310 (3 pcs)

\* 3/8"sq. socket holder is not included.

Spare parts

No.	Description	Weight(g)	
NTX759CT2	Tray	500	

Packing unit 1

3/8"sq. TOOL SET [33pcs.]

3/8" sq.

inch

33 pcs.

90



Top part



1st drawer



2nd drawer



3rd drawer



NTX734BCT2



No.	Number of tools	Weight(kg)	
NTX734BC	33	17	

Set contents	
NTX734BCT	Assembly and trays ×1
EKR-103NB	Chest ×1 (W510×D275×H325)

Packing unit 1 (2 units)	
Contents	
3/8"sq. socket (6pt.)	NB3-1/4,5/16,3/8,7/16,1/2,9/16,19/32, 5/8,11/16,3/4,13/16,7/8,15/16
3/8"sq. ratchet handle	NBR390A
3/8"sq. Breaker bar	NBS3
3/8"sq. extension bar	NBE3-075,150
3/8"sq. quick spinner	NBE38
3/8"sq. universal joint	NBJ3
Combination wrenches	NMS2-5/16,3/8,7/16,1/2,9/16,11/16
Adjustable wrench	NWM-250
Pliers	NPJ-200
Radio pliers	NPSL-150
Wide Nippers	NPN-150BW
Wooden grip screwdriver (stubby flat)	ND3M-055,06
Wooden grip screwdriver (stubby cross)	ND3P-1,2
3/8"sq. socket holder	NEHB310 (2 pcs)

\* 3/8"sq. socket holder is not included.

Spare parts

No.	Description	Weight(g)	
NTX734BCT2	Tray	500	

\* Display (laser marking) is different from NTX759CT2.

Packing unit 1

• Do not use hand tools with an impact wrench.

3/8"sq. TOOL SET [27pcs.]

3/8" sq.  
27 pcs.  
90



Top part

1st drawer



2nd drawer

3rd drawer

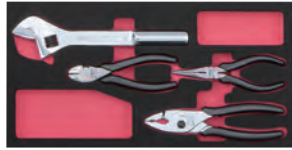

NTX759CT2



No.	Number of tools	Weight(kg)	
NTX727C	27	16.5	
Set contents			
NTX727CT	Assembly and trays	× 1	
EKR-103NB	Chest	× 1 (W510×D275×H325)	
Packing unit 1 (2 units)			
Contents			
3/8"sq. socket (6pt.)	NB3-08,10,12,13,14,17,19		
3/8"sq. ratchet handle	NBR390A		
3/8"sq. Breaker bar	NBS3		
3/8"sq. extension bar	NBE3-075,150		
3/8"sq. quick spinner	NBE38		
3/8"sq. universal joint	NB3J		
Combination wrenches	NMS2-08,10,12,13,14,17		
Adjustable wrench	NWM-250		
Pliers	NPJ-200		
Radio pliers	NPSL-150		
Wide Nippers	NPN-150BW		
Wooden grip screwdriver (stubby flat)	ND3M-055,06		
Wooden grip screwdriver (stubby cross)	ND3P-1,2		
3/8"sq. socket holder	NEHB310		

\* 3/8"sq. socket holder is not included.

Spare parts

No.	Description	Weight(g)	
NTX759CT2	Tray	500	

Packing unit 1

3/8"sq. TOOL SET [32pcs.]

3/8" sq.  
32 pcs.  
90



No.	Number of tools	Weight(kg)	
NTX632WAZ	32	13	
Case			
Dedicated double-folding metal case	EK-10ANTH25		
Packing unit 1			
Contents			
3/8"sq. socket (6pt.)	NB3-08,10,12,13,14,17		
3/8"sq. deep socket (12pt.)	NB3L-10W,12W,14W		
3/8"sq. hexagonal bit socket	NBT3-04,05,06		
3/8"sq. ratchet handle	NBR390A		
3/8"sq. compact ratchet handle	NBRC390		
3/8"sq. quick spinner	NBE38		
3/8"sq. quick spinner (compact)	NBEC38		
3/8"sq. extension bar	NBE3-075,150		
3/8"sq. universal joint	NB3J		
Plastic grip screwdriver (flat)	ND1M2-5,6		
Plastic grip screwdriver (cross)	ND1P2-1,2		
Combination wrenches	NMS2-08,10,12,13,14,17		
Adjustable wrench	NWM-250		
Nippers	NPN-150		
Radio pliers	NPSL-150		

• This model comes with an exclusive double-folding metal case.  
• The storage tray is made of foamed polyethylene.  
• The case of the "EK-10A" is colored exclusively for nepros.

• Function mark is indicated under the product name. For the details, please refer to P.004-005.  
• Products marked with ⚠ should be ordered after checking stock.





**3/8"sq. TOOL SET [77pcs.]**

3/8" sq.

77 pcs.



NTX10770BKN



NTX10770RN



NTX10770SN



NTX10770WHN

No.	Number of tools	Weight(kg)	
NTX10770RN	77	91	
Set contents			
NTX10770R			
Imprinting Fee			
Packing unit 1 (2 units)			
No.	Number of tools	Weight(kg)	
NTX10770BKN	77	91	
Set contents			
NTX10770BK			
Imprinting Fee			
Packing unit 1 (2 units)			
No.	Number of tools	Weight(kg)	
NTX10770SN	77	91	
Set contents			
NTX10770S			
Imprinting Fee			
Packing unit 1 (2 units)			
No.	Number of tools	Weight(kg)	
NTX10770WHN	77	91	
Set contents			
NTX10770WH			
Imprinting Fee			
· We can laser-engage your name or initials on the inserts of the NTX10770R, NTX10770BK, NTX10770S, and NTX10770WH nepros Tool Sets.			
Packing unit 1 (2 units)			

**3/8"sq. TOOL SET [77pcs.]**

3/8" sq.

77 pcs.



NTX8770BKN



NTX8770RN



NTX8770SN



NTX8770WHN

No.	Number of tools	Weight(kg)	
NTX8770RN	77	48	
Set contents			
NTX8770R			
Imprinting Fee			
Packing unit 1 (2 units)			
No.	Number of tools	Weight(kg)	
NTX8770BKN	77	48	
Set contents			
NTX8770BK			
Imprinting Fee			
Packing unit 1 (2 units)			
No.	Number of tools	Weight(kg)	
NTX8770SN	77	48	
Set contents			
NTX8770S			
Imprinting Fee			
Packing unit 1 (2 units)			
No.	Number of tools	Weight(kg)	
NTX8770WHN	77	48	
Set contents			
NTX8770WH			
Imprinting Fee			
· We will laser-engage your name or initials on the inserts of the nepros Tool Set NTX8770R, NTX8770BK, NTX8770S, and NTX8770WH.			
Packing unit 1 (2 units)			

· Do not use hand tools with an impact wrench.

**3/8"sq. TOOL SET [60pcs.]**

3/8" sq.

60 pcs.



No.	Number of tools	Weight(kg)	
NTX759CN	60	19.5	
Set contents			
NTX759C			
Imprinting Fee			

· We will laser-engage your name or initials on the inserts of the nepros Tool Set NTX759C.  
Packing unit 1 (2 units)

nepros TOOL SET

**3/8"sq. TOOL SET [42pcs.]**

3/8" sq.

42 pcs.



No.	Number of tools	Weight(kg)	
NTX740CN	42	17.5	
Set contents			
NTX740C			
Imprinting Fee			

· We can laser-engage your name or initials on the inserts of the nepros Tool Set NTX740C.  
Packing unit 1 (2 units)

· Function mark is indicated under the product name. For the details, please refer to P.004-005.  
· Products marked with should be ordered after checking stock.





nepros

---

# SOCKETS AND DRIVE TOOLS

1/4"sq. SOCKET SET [22pcs.]

1/4" sq.

22 pcs.

90

6pt.



No.	Weight(g)
NTB222XA	705
Set contents	
Sockets (6pt.)	NB2-04,05,055,06,07,08,09,10,11,12,13,14
Ratchet handle	NBR290
Breaker bar	NBS2
Quick spinner	NBE28
Extension bar	NBE2-025,050,075,150
Universal joint	NBJ2
Slide head handle	NBHM2
Driver Type Handle	NBD12

· Includes plastic tray (W265×D145×H35).  
 \* Resin trays do not fit into NEKB-1 and EKB-1 (metal case).  
 Packing unit 1

1/4"sq. SOCKET SET [5pcs.]

1/4" sq.

5 pcs.

6pt.



No.	Weight(g)
NTB205A	200
Set contents	
Sockets (6pt.)	NB2-08,10,12,13,14
Socket holder for 6 sockets	NEHB206

· Socket set in a nepros 1/4"sq. socket holder.  
 Packing unit 1

1/4"sq. SOCKET SET [6pcs.]

1/4" sq.

6 pcs.

6pt.



No.	Weight(g)
NTB206A	221
Set contents	
Sockets (6pt.)	NB2-055,08,10,12,13,14
Socket holder for 6 sockets	NEHB206

· Socket set in a nepros 1/4"sq. socket holder.  
 Packing unit 1

1/4"sq. SOCKET SET [10pcs.]

1/4" sq.

10 pcs.

6pt.



No.	Weight(g)
NTB210A	284
Set contents	
Sockets (6pt.)	NB2-055,06,07,08,09,10,11,12,13,14
Socket holder for 10 sockets	NEHB210

· Socket set in a nepros 1/4"sq. socket holder.  
 Packing unit 1

1/4"sq. SOCKET SET [12pcs.]

1/4" sq.

12 pcs.

6pt.



No.	Weight(g)
NTB212A	300
Set contents	
Sockets (6pt.)	NB2-04,05,055,06,07,08,09,10,11,12,13,14
Socket holder for 15 sockets	NEHB215

· Socket set in a nepros 1/4"sq. socket holder.  
 Packing unit 1

1/4"sq. SOCKET SET [6pcs.]

1/4" sq.

6 pcs.

12pt.



No.	Weight(g)
NTB206WA	220
Set contents	
Sockets (12pt.)	NB2-055W,08W,10W,12W,13W,14W
Socket holder for 6 sockets	NEHB206

· Socket set in a nepros 1/4"sq. socket holder.  
 Packing unit 1

· Function mark is indicated under the product name. For the details, please refer to P.004-005.  
 · Products marked with should be ordered after checking stock.



**1/4"sq. SOCKET SET [8pcs.]**



No.	NTB208WA	
Weight(g)	265	
Set contents		
Sockets (12pt.)	NB2-055W,06W,08W,10W,11W,12W,13W,14W	
Socket holder for 10 sockets	NEHB210	
· Socket set in a nepros 1/4"sq. socket holder. Packing unit 1		

**1/4"sq. SOCKET SET [6pcs.]**



No.	NTB206BA	
Weight(g)	265	
Set contents		
Sockets (6pt.)	NB2-7/32,1/4,9/32,5/16,3/8,7/16	
Socket holder for 6 sockets	NEHB206	
· Inch size socket set in a nepros 1/4"sq. socket holder. Packing unit 1		

**1/4"sq. SOCKET SET [10pcs.]**



No.	NTB210BA	
Weight(g)	271	
Set contents		
Sockets (6pt.)	NB2-3/16,7/32,1/4,9/32,5/16,11/32,3/8,7/16,1/2,9/16	
Socket holder for 10 sockets	NEHB210	
· Inch size socket set in a nepros 1/4"sq. socket holder. Packing unit 1		

**1/4"sq. SOCKET SET [9pcs.]**



No.	NTB209BWA	
Weight(g)	263	
Set contents		
Sockets (12pt.)	NB2-7/32W,1/4W,9/32W,5/16W,11/32W,3/8W,7/16W,1/2W,9/16W	
Socket holder for 10 sockets	NEHB210	
· Inch size socket set in a nepros 1/4"sq. socket holder. Packing unit 1		

**1/4"sq. SOCKET**



No.	S	D1	D2	H	L	Weight(g)
NB2-04	4	6.3	12	3	16	8
NB2-05	5	7.5	12	3	16	8
NB2-055	5.5	8.1	12	5	18	8
NB2-06	6	8.7	12	5	18	8
NB2-07	7	9.8	12	5	18	8
NB2-08	8	11	12	5.5	18.5	9
NB2-09	9	12.2	13	5.5	18.5	11
NB2-10	10	13.4	13	5.5	18.5	11
NB2-11	11	14.6	13.5	6	19	12
NB2-12	12	15.8	14.5	7.5	20.5	16
NB2-13	13	17.2	16	7.5	20.5	20
NB2-14	14	18.3	17	8.5	21.5	22

Packing unit 5

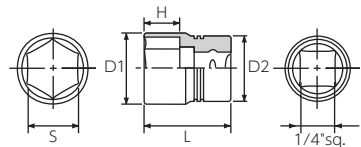

· Do not use hand tools with an impact wrench.

1/4"sq. SOCKET



No.	S	D1	D2	H	L	Weight(g)
NB2-055W	5.5	8.1	12	5	18	8
NB2-06W	6	8.7	12	5	18	8
NB2-08W	8.1	11	12	5.5	18.5	9
NB2-10W	10	13.4	13	5.5	18.5	11
NB2-11W	11	14.6	13.5	6	19	12
NB2-12W	12	15.8	14.5	7.5	20.5	16
NB2-13W	13	17.2	16	7.5	20.5	20
NB2-14W	14	18.3	17	8.5	21.5	22

Packing unit 5

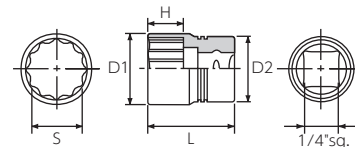

1/4"sq. SOCKET



No.	S	D1	D2	H	L	Weight(g)
NB2-1/8	1/8	6	12	2.5	16	8
NB2-5/32	5/32	6	12	3	16	8
NB2-3/16	3/16	7.1	12	3	16	8
NB2-7/32	7/32	8.1	12	5	18	8
NB2-1/4	1/4	9	12	5	18	8
NB2-9/32	9/32	9.8	12	5	18	8
NB2-5/16	5/16	10.8	12	5.5	18.5	9
NB2-11/32	11/32	12	12	5.5	18.5	9
NB2-3/8	3/8	13	12	5.5	18.5	9
NB2-7/16	7/16	14.5	13	6	19	11
NB2-1/2	1/2	17	15.5	7.5	20.5	19
NB2-9/16	9/16	18.5	17	8.5	21.5	23

Packing unit 5

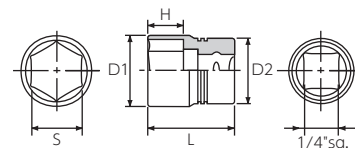

1/4"sq. SOCKET



No.	S	D1	D2	H	L	Weight(g)
NB2-7/32W	7/32	8.1	12	5	18	8
NB2-1/4W	1/4	9	12	5	18	8
NB2-9/32W	9/32	9.8	12	5	18	8
NB2-5/16W	5/16	10.8	12	5.5	18.5	9
NB2-11/32W	11/32	12	12	5.5	18.5	9
NB2-3/8W	3/8	13	12	5.5	18.5	9
NB2-7/16W	7/16	14.5	13	6	19	11
NB2-1/2W	1/2	17	15.5	7.5	20.5	19
NB2-9/16W	9/16	18.5	17	8.5	21.5	23

Packing unit 5

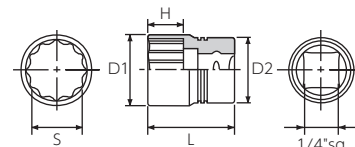

1/4"sq. SEMI DEEP SOCKET SET [6pcs.]



No.	Weight(g)
NTB2M06A	285
Set contents	
Semi-deep sockets (6pt.)	NB2M-055,08,10,12,13,14
Socket holder for 6 sockets	NEHB206

· Semi-deep socket set in a nepros 1/4"sq. socket holder.

Packing unit 1

· Function mark is indicated under the product name. For the details, please refer to P.004-005.  
 · Products marked with should be ordered after checking stock.



1/4"sq. SEMI DEEP SOCKET SET [10pcs.]



No.	Weight(g)	
NTB2M10A	365	
Set contents		
Semi-deep sockets (6pt.)	NB2M-055,06,07,08,09,10,11,12,13,14	
Socket holder for 10 sockets	NEHB210	
· Semi-deep socket set in a nepros 1/4"sq. socket holder.		
Packing unit 1		

1/4"sq. SEMI DEEP SOCKET SET [6pcs.]



No.	Weight(g)	
NTB2M06WA	283	
Set contents		
Semi-deep sockets (12pt.)	NB2M-055W,08W,10W,12W,13W,14W	
Socket holder for 6 sockets	NEHB206	
· Semi-deep socket set in a nepros 1/4"sq. socket holder.		
Packing unit 1		

1/4"sq. SEMI DEEP SOCKET SET [8pcs.]



No.	Weight(g)	
NTB2M08WA	333	
Set contents		
Semi-deep sockets (12pt.)	NB2M-055W,06W,08W,10W,11W,12W,13W,14W	
Socket holder for 10 sockets	NEHB210	
· Semi-deep socket set in a nepros 1/4"sq. socket holder.		
Packing unit 1		

1/4"sq. SEMI DEEP SOCKET

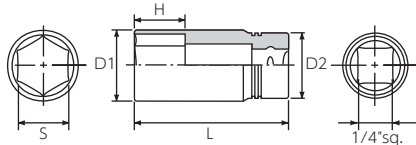

No.	S	D1	D2	H	L	Weight(g)
NB2M-04	4	6.3	12	3	28	12
NB2M-05	5	7.5	12	3	28	12
NB2M-055	5.5	8.1	12	5	30	13
NB2M-06	6	8.7	12	5	30	13
NB2M-07	7	9.8	12	5	30	14
NB2M-08	8	11	12	5.5	30	15
NB2M-09	9	12.2	13	5.5	30	18
NB2M-10	10	13.4	13	5.5	30	19
NB2M-11	11	14.6	13.5	6	32	23
NB2M-12	12	15.8	14.5	7.5	32	26
NB2M-13	13	17.2	16	7.5	32	31
NB2M-14	14	18.3	17	8.5	32	35

Packing unit 5

1/4"sq. SEMI DEEP SOCKET

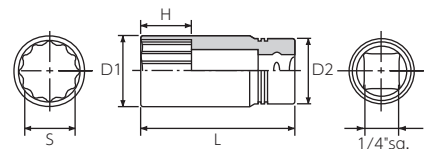

No.	S	D1	D2	H	L	Weight(g)
NB2M-055W	5.5	8.1	12	5	30	13
NB2M-06W	6	8.7	12	5	30	13
NB2M-08W	8	11	12	5.5	30	15
NB2M-10W	10	13.4	13	5.5	30	19
NB2M-11W	11	14.6	13.5	6	32	22
NB2M-12W	12	15.8	14.5	7.5	32	25
NB2M-13W	13	17.2	16	7.5	32	31
NB2M-14W	14	18.3	17	8.5	32	34

Packing unit 5

· Do not use hand tools with an impact wrench.



1/4"sq. DEEP SOCKET SET [6pcs.]



No.	Weight(g)	
NTB2L06A	351	
Set contents		
Deep sockets (6pt.)	NB2L-055,08,10,12,13,14	
Socket holder for 6 sockets	NEHB206	
· Deep socket set in a nepros 1/4"sq. socket holder.		
Packing unit 1		

1/4"sq. DEEP SOCKET SET [9pcs.]



No.	Weight(g)	
NTB2L09A	400	
Set contents		
Deep sockets (6pt.)	NB2L-04,05,055,08,10,11,12,13,14	
Socket holder for 10 sockets	NEHB210	
· Socket set in a nepros 1/4"sq. socket holder.		
Packing unit 1		

1/4"sq. DEEP SOCKET SET [6pcs.]



No.	Weight(g)	
NTB2L06WA	340	
Set contents		
Deep socket (12pt.)	NB2L-055W,08W,10W,12W,13W,14W	
Socket holder for 6 sockets	NEHB206	
· Socket set in a nepros 1/4"sq. socket holder.		
Packing unit 1		

1/4"sq. DEEP SOCKET SET [8pcs.]



No.	Weight(g)	
NTB2L08WA	429	
Set contents		
Deep socket (12pt.)	NB2L-055W,06W,08W,10W,11W,12W,13W,14W	
Socket holder for 10 sockets	NEHB210	
· Deep socket set in a nepros 1/4"sq. socket holder.		
Packing unit 1		

1/4"sq. DEEP SOCKET SET [6pcs.]



No.	Weight(g)	
NTB2L06BA	289	
Set contents		
Deep sockets (6pt.)	NB2L-7/32,1/4,9/32,5/16,3/8,7/16	
Socket holder for 6 sockets	NEHB206	
· Inch size deep socket set in nepros 1/4"sq. socket holder.		
Packing unit 1		

1/4"sq. DEEP SOCKET SET [9pcs.]



No.	Weight(g)	
NTB2L09BWA	439	
Set contents		
Deep socket (12pt.)	NB2L-7/32W,1/4W,9/32W,5/16W,11/32W,3/8W,7/16W,1/2W,9/16W	
Socket holder for 10 sockets	NEHB210	
· Inch size deep socket set in nepros 1/4"sq. socket holder.		
Packing unit 1		

· Function mark is indicated under the product name. For the details, please refer to P.004-005.  
 · Products marked with should be ordered after checking stock.



**1/4"sq. DEEP SOCKET**



No.	S	D1	D2	H	L	Weight(g)
NB2L-04	4	6.3	12	5	50	16
NB2L-05	5	7.5	12	5	50	18
NB2L-055	5.5	8.1	12	6	50	19
NB2L-06	6	8.7	12	6	50	20
NB2L-07	7	9.8	12	8	50	22
NB2L-08	8	11	12	9	50	23
NB2L-09	9	12.2	13	10	50	27
NB2L-10	10	13.4	13	11	50	29
NB2L-11	11	14.6	13.5	12	50	32
NB2L-12	12	15.8	14.5	14	50	37
NB2L-13	13	17.2	16	14	50	45
NB2L-14	14	18.3	17	17	50	52

Packing unit 5

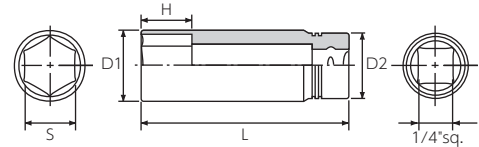

**1/4"sq. DEEP SOCKET**



No.	S	D1	D2	H	L	Weight(g)
NB2L-055W	5.5	8.1	12	6	50	19
NB2L-06W	6	8.7	12	6	50	20
NB2L-08W	8	11	12	9	50	23
NB2L-10W	10	13.4	13	11	50	29
NB2L-11W	11	14.6	13.5	12	50	32
NB2L-12W	12	15.8	14.5	14	50	37
NB2L-13W	13	17.2	16	14	50	45
NB2L-14W	14	18.3	17	17	50	52

Packing unit 5

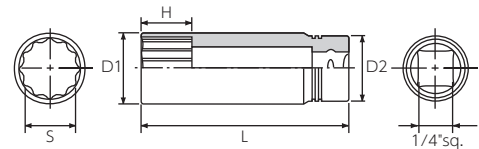

**1/4"sq. DEEP SOCKET**



No.	S	D1	D2	H	L	Weight(g)
NB2L-1/8	1/8	6	12	5	50	15
NB2L-5/32	5/32	6	12	5	50	16
NB2L-3/16	3/16	7.1	12	5	50	18
NB2L-7/32	7/32	8.1	12	6	50	19
NB2L-1/4	1/4	9	12	6	50	20
NB2L-9/32	9/32	9.8	12	8	50	21
NB2L-5/16	5/16	10.8	12	9	50	23
NB2L-11/32	11/32	12	12	10	50	27
NB2L-3/8	3/8	13	12	11	50	28
NB2L-7/16	7/16	14.5	13	12	50	32
NB2L-1/2	1/2	17	15.5	14	50	45
NB2L-9/16	9/16	18.5	17	17	50	52

Packing unit 5

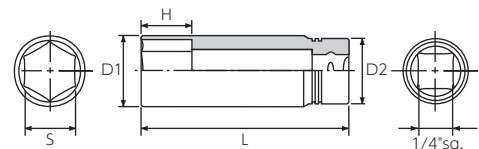

• Do not use hand tools with an impact wrench.

1/4"sq. DEEP SOCKET



No.	S	D1	D2	H	L	Weight(g)
NB2L-7/32W	7/32	8.1	12	6	50	19
NB2L-1/4W	1/4	9	12	6	50	20
NB2L-9/32W	9/32	9.8	12	8	50	21
NB2L-5/16W	5/16	10.8	12	9	50	23
NB2L-11/32W	11/32	12	12	10	50	27
NB2L-3/8W	3/8	13	12	11	50	28
NB2L-7/16W	7/16	14.5	13	12	50	32
NB2L-1/2W	1/2	17	15.5	14	50	45
NB2L-9/16W	9/16	18.5	17	17	50	52

Packing unit 5

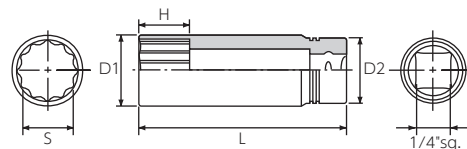

1/4"sq. CROWFOOT WRENCH



No.	S	W	T	L	B	Weight(g)
NBNS2-08W	8	17	8	33	20	20
NBNS2-10W	10	21	8	34	20	22
NBNS2-12W	12	23	8	35	20	25

- The curved shape makes it possible to work in tight spaces, which was difficult with 3/8"sq. This is especially suitable motorbike ABS where pipes are lined up at narrow intervals.
- The aperture part has a power-fit shape that prevents stress concentration to prevent damage to the edge of the bolt/nut and allows for more secure tightening/loosening work.
- The distance between the center of aperture and square drive is set to common size (20mm), making it easy to calculate when combined with a torque wrench.

Packing unit 5

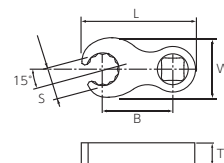

1/4"sq. HEX. BIT SOCKET SET (STUBBY) [6pcs.]

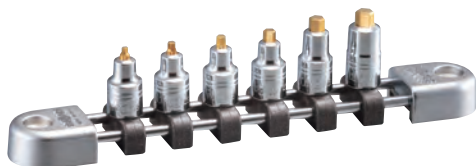

No.	Weight(g)
NTBT2SS06A	215

Set contents

Stubby Hexagonal Bit Socket	NBT2-02SS,025SS,03SS,04SS,05SS,06SS
Socket holder for 6 sockets	NEHB206

- Bit socket set in a nepros 1/4"sq. socket holder.
- TiN (titanium) coating improves wear resistance.
- The short length of the bit prevents twisting and transmits power without loss, making it suitable for loosening adhered bolts.
- \* The TiN coating on the bit is not intended to prevent rust. Please take care of the bits by applying oil, etc.

Packing unit 1

1/4"sq. HEX. BIT SOCKET SET [5pcs.]



No.	Weight(g)
NTBT205A	200

Set contents

Hexagonal bit socket	NBT2-04,05,06
Cross bit socket	NBT2P-1,2
Socket holder for 6 sockets	NEHB206

- Bit socket set in a nepros 1/4"sq. socket holder.
- TiN (titanium) coating improves wear resistance.
- \* The TiN coating on the bit is not intended to prevent rust. Please take care of the bits by applying oil, etc.

Packing unit 1

• Function mark is indicated under the product name. For the details, please refer to P.004-005.  
 • Products marked with should be ordered after checking stock.



1/4"sq. HEX. BIT SOCKET SET [6pcs.]

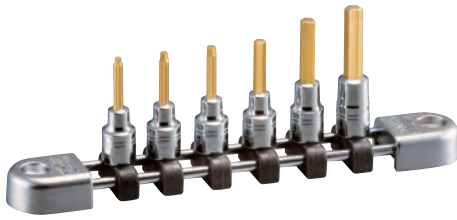

No.	Weight(g)
NTBT206A	230
Set contents	
Hexagonal bit socket	NBT2-02,025,03,04,05,06
Socket holder for 6 sockets	NEHB206

- Bit socket set in a nepros 1/4"sq. socket holder.
  - TiN (titanium) coating improves wear resistance.
  - Round shaft design is adopted for sizes with a hexagonal double face width of 3 mm or less. Excellent rigidity is realized.
  - \* The TiN coating on the bit is not intended to prevent rust. Please take care of the bits by applying oil, etc.
- Packing unit 1

1/4"sq. HEX. BIT SOCKET SET [9pcs.]



No.	Weight(g)
NTBT209A	315
Set contents	
Hexagonal bit socket	NBT2-02,025,03,04,05,06
Cross bit socket	NBT2P-1,2
Flat Bit Socket	NBT2M-06
Socket holder for 10 sockets	NEHB210

- Bit socket set in a nepros 1/4"sq. socket holder.
  - TiN (titanium) coating improves wear resistance.
  - Round shaft design is adopted for sizes with a hexagonal double face width of 3 mm or less. Excellent rigidity is realized.
  - \* The TiN coating on the bit is not intended to prevent rust. Please take care of the bits by applying oil, etc.
- Packing unit 1

1/4"sq. HEX. BIT SOCKET SET (LONG) [6pcs.]



No.	Weight(g)
NTBT2L06A	294
Set contents	
Long Hexagonal Bit Socket	NBT2-02L,025L,03L,04L,05L,06L
Socket holder for 6 sockets	NEHB206

- Bit socket set in a nepros 1/4"sq. socket holder.
  - TiN (titanium) coating improves wear resistance.
  - Round shaft design is adopted for sizes with a hexagonal double face width of 3 mm or less. Excellent rigidity is realized.
  - \* The TiN coating on the bit is not intended to prevent rust. Please take care of the bits by applying oil, etc.
- Packing unit 1

1/4"sq. HEX. BIT SOCKET (STUBBY)

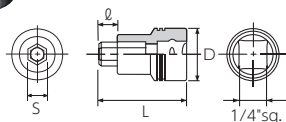

No.	S	D	L	ℓ	Weight(g)
NBT2-02SS	2	12	23.7	4	10
NBT2-025SS	2.5	12	23.7	4	10
NBT2-03SS	3	12	23.7	4	10
NBT2-04SS	4	12	23.7	4	11
NBT2-05SS	5	12	26.2	4.5	13
NBT2-06SS	6	12	26.7	5	15

- Stubby type suitable for working in narrow spaces.
  - The short length of the bit prevents twisting and transmits power without loss, making it suitable for loosening adhered bolts.
  - TiN (titanium) coating improves wear resistance.
  - The hexagonal bolt can be inserted smoothly with the hexagon socket head bolt.
  - \* The TiN coating on the bit is not intended to prevent rust. Please take care of the bits by applying oil, etc.
- Packing unit 5

• Do not use hand tools with an impact wrench.

### 1/4"sq. HEX. BIT SOCKET



No.	S	D	L	ℓ	Weight(g)
NBT2-02	2	12	38.7	19	11
NBT2-025	2.5	12	38.7	19	11
NBT2-03	3	12	38.7	19	12
NBT2-04	4	12	38.7	19	13
NBT2-05	5	12	44.7	23	16
NBT2-06	6	12	47.7	26	21

- TiN (titanium) coating improves abrasion resistance.
- Chamfered tip for smooth insertion into hexagon socket head bolts.
- A round shaft is used for hexagonal two-face widths of 3 mm or less to prevent twisting.
- \* The TiN coating on the bit is not intended to prevent rust. Please take care of the bits by applying oil, etc.

Packing unit 5

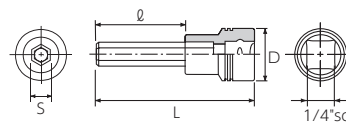

### 1/4"sq. HEX. BIT SOCKET (LONG)



No.	S	D	L	ℓ	Weight(g)
NBT2-02L	2	12	79.7	60	15
NBT2-025L	2.5	12	79.7	60	15
NBT2-03L	3	12	79.7	60	15
NBT2-04L	4	12	79.7	60	16
NBT2-05L	5	12	84.7	63	22
NBT2-06L	6	12	91.7	70	31

- Since you can approach the target without using an extension bar, you can work in deep holes with small diameters or in places where there are obstacles above and it is difficult to approach with a driver type.
- TiN (titanium) coating improves wear resistance.
- The hexagonal bolt can be inserted smoothly with the hexagon socket head bolt.
- \* The TiN coating on the bit is not intended to prevent rust. Please take care of the bits by applying oil, etc.

Packing unit 5

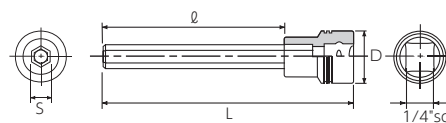

### 1/4"sq. CROSS BIT SOCKET (STUBBY)



No.	size	D	L	ℓ	Weight(g)
NBT2P-1SS	No.1	12	32.7	11	15
NBT2P-2SS	No.2	12	34	12.3	16

- Stubby type suitable for working in narrow spaces.
- The short overall length of the bit prevents twisting and transmits applied force without loss.
- TiN (titanium) coating improves wear resistance.
- \* The TiN coating on the bit is not intended to prevent rust. Please take care of the bits by applying oil, etc.

Packing unit 5

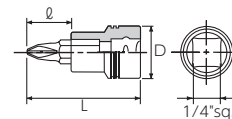

### 1/4"sq. CROSS BIT SOCKET

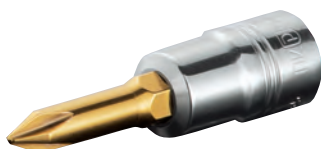

No.	size	D	L	ℓ	Weight(g)
NBT2P-1	No.1	12	44.7	23	19
NBT2P-2	No.2	12	47.7	26	20

- TiN (titanium) coating improves abrasion resistance.
- \* The TiN coating on the bit is not intended to prevent rust. Please take care of the bits by applying oil, etc.

Packing unit 5

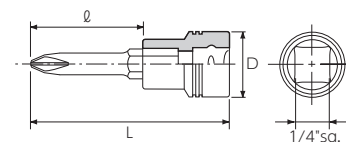

· Function mark is indicated under the product name. For the details, please refer to P.004-005.  
 · Products marked with should be ordered after checking stock.





1/4"sq. CROSS BIT SOCKET (LONG)



No.	size	D	L	ℓ	Weight(g)
NBT2P-1L	No.1	12	92.7	71	26
NBT2P-2L	No.2	12	92.7	71	29

- Since you can approach the target without using an extension bar, you can work in deep holes with small diameters or in places where there are obstacles above and it is difficult to approach with a driver type.
- TiN (titanium) coating improves wear resistance.
- \* The TiN coating on the bit is not intended to prevent rust. Please take care of the bits by applying oil, etc.

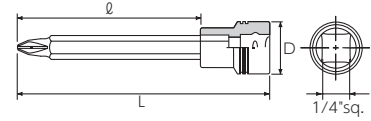

1/4"sq. FLAT BIT SOCKET (STUBBY)



No.	D	L	ℓ	Weight(g)
NBT2M-06SS	12	30	8.3	15

- Stubby type suitable for working in narrow spaces.
- The short overall length of the bit prevents twisting and transmits applied force without loss.
- TiN (titanium) coating improves wear resistance.
- \* The TiN coating on the bit is not intended to prevent rust. Please take care of the bits by applying oil, etc.

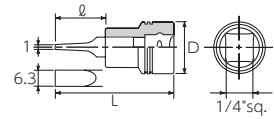

1/4"sq. FLAT BIT SOCKET



No.	D	L	ℓ	Weight(g)
NBT2M-06	12	47.7	26	20

- TiN (titanium) coating improves abrasion resistance.
- \* The TiN coating on the bit is not intended to prevent rust. Please take care of the bits by applying oil, etc.

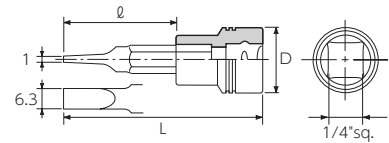

1/4"sq. FLAT BIT SOCKET (LONG)



No.	D	L	ℓ	Weight(g)
NBT2M-06L	12	92.7	71	29

- Since you can approach the target without using an extension bar, you can work in deep holes with small diameters or in places where there are obstacles above and it is difficult to approach with a driver type.
- TiN (titanium) coating improves wear resistance.
- \* The TiN coating on the bit is not intended to prevent rust. Please take care of the bits by applying oil, etc.

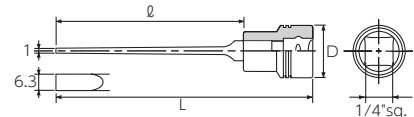

1/4"sq. T-TYPE TORX BIT SOCKET SET (STUBBY) [7pcs.]



No.	Weight(g)
NTQ4T07SS	245

Set contents	
Stubby T-type Torx Bit Socket	NQ4T8SS, 10SS, T15SS, T20SS, T25SS, T27SS, T30SS
Socket holder for 10 sockets	NEHB210

- Bit socket set in a nepros 1/4"sq. socket holder.
- Stubby type suitable for working in narrow spaces.
- The short overall length of the bit prevents twisting and transmits applied force without loss, making it suitable for loosening adhered bolts.
- TiN (titanium) coating improves wear resistance.
- \* The TiN coating on the bit is not intended to prevent rust. Please take care of the bits by applying oil, etc.

• Do not use hand tools with an impact wrench.

1/4"sq. T-TYPE TORX BIT SOCKET SET [5pcs.]



No.	Weight(g)	
NTQ4T05A	200	
Set contents		
T-type Torx Bit Socket	NQ4T10,T15,T20,T25,T27	
Socket holder for 6 sockets	NEHB206	
<ul style="list-style-type: none"> <li>Bit socket set in a nepros 1/4"sq. socket holder.</li> <li>TiN (titanium) coating improves abrasion resistance.</li> </ul>		
* The TiN coating on the bit is not intended to prevent rust. Please take care of the bits by applying oil, etc.		
Packing unit 1		

1/4"sq. T-TYPE TORX BIT SOCKET SET [7pcs.]



No.	Weight(g)	
NTQ4T07	270	
Set contents		
T-type Torx Bit Socket	NQ4T8,T10,T15,T20,T25,T27,T30	
Socket holder for 10 sockets	NEHB210	
<ul style="list-style-type: none"> <li>Bit socket set in a nepros 1/4"sq. socket holder.</li> <li>TiN (titanium) coating improves wear resistance.</li> </ul>		
* The TiN coating on the bit is not intended to prevent rust. Please take care of the bits by applying oil, etc.		
Packing unit 1		

1/4"sq. T-TYPE TORX BIT SOCKET SET (LONG) [7pcs.]



No.	Weight(g)	
NTQ4T07L	330	
Set contents		
Long T-type Torx Bit Socket	NQ4T8L,T10L,T15L,T20L,T25L,T27L,T30L	
Socket holder for 10 sockets	NEHB210	
<ul style="list-style-type: none"> <li>The ability to approach an object without the use of an extension bar enables work in deep holes with small diameters or in areas that are difficult to approach with a screwdriver type due to obstructions above.</li> <li>Bit socket set in a nepros 1/4"sq. socket holder.</li> <li>TiN (titanium) coating improves abrasion resistance.</li> </ul>		
* The TiN coating on the bit is not intended to prevent rust. Please take care of the bits by applying oil, etc.		
Packing unit 1		

1/4"sq. T-TYPE TORX BIT SOCKET (STUBBY)

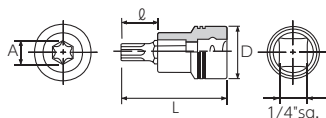

No.	size	A	D	L	ℓ	Weight(g)
NQ4T8SS	T8	2.3	12	27	7.3	10
NQ4T10SS	T10	2.7	12	27	7.3	10
NQ4T15SS	T15	3.2	12	27	7.3	10
NQ4T20SS	T20	3.8	12	30.2	8.5	13
NQ4T25SS	T25	4.4	12	30.2	8.5	13
NQ4T27SS	T27	4.9	12	30.4	8.7	13
NQ4T30SS	T30	5.4	12	31.6	9.9	16

- Stubby type suitable for working in narrow spaces.
- The short overall length of the bit prevents twisting and transmits applied force without loss, making it suitable for loosening adhered bolts.
- TiN (titanium) coating improves wear resistance.

Packing unit 5

1/4"sq. T-TYPE TORX BIT SOCKET

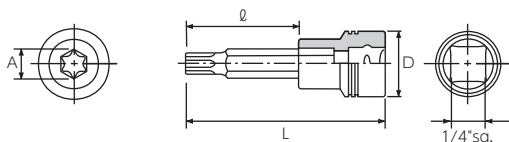

No.	size	A	D	L	ℓ	Weight(g)
NQ4T8	T8	2.3	12	38.7	19	12
NQ4T10	T10	2.7	12	38.7	19	12
NQ4T15	T15	3.2	12	38.7	19	12
NQ4T20	T20	3.8	12	38.7	19	12
NQ4T25	T25	4.4	12	44.7	23	16
NQ4T27	T27	4.9	12	44.7	23	16
NQ4T30	T30	5.4	12	44.7	23	19

- TiN (titanium) coating improves abrasion resistance.
- The TiN coating on the bit is not intended to prevent rust. Please take care of the bits by applying oil, etc.

Packing unit 5

· Function mark is indicated under the product name. For the details, please refer to P.004-005.  
 · Products marked with should be ordered after checking stock.



1/4"sq. T-TYPE TORX BIT SOCKET (LONG)

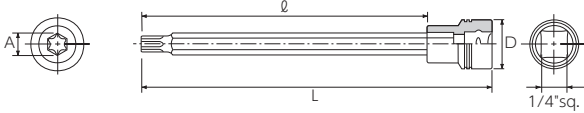

No.	size	A	D	L	ℓ	Weight(g)
NQ4T8L	T8	2.3	12	79.7	60	15
NQ4T10L	T10	2.7	12	79.7	60	15
NQ4T15L	T15	3.2	12	79.7	60	15
NQ4T20L	T20	3.8	12	84.7	63	21
NQ4T25L	T25	4.4	12	84.7	63	21
NQ4T27L	T27	4.9	12	84.7	63	27
NQ4T30L	T30	5.4	12	84.7	63	27

- The ability to approach an object without the use of an extension bar enables work in deep holes with small diameters or in areas that are difficult to approach with a screwdriver type due to obstructions above.
  - TiN (titanium) coating improves wear resistance.
- Packing unit 5

1/4"sq. E-TYPE TORX SOCKET SET [5pcs.]



No.	Weight(g)
NTQ4E05A	200

Set contents	
E-type Torx Wrench	NQ4E4,E5,E6,E8,E10
Socket holder for 6 sockets	NEHB206

- E-type Torx wrench set in a nepros 1/4"sq. socket holder.
- Packing unit 1

1/4"sq. E-TYPE TORX SOCKET



No.	size	A	D1	D2	L	Weight(g)
NQ4E4	E4	3.86	5.4	12	17	8
NQ4E5	E5	4.75	6.4	12	17.5	9
NQ4E6	E6	5.74	7.4	12	17.5	9
NQ4E8	E8	7.52	9.3	12	19	10
NQ4E10	E10	9.42	11.2	12	20.5	11

Packing unit 5

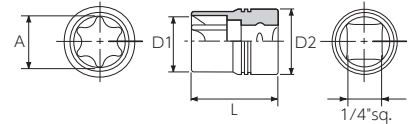

1/4"sq. RATCHET HANDLE

IF DESIGN AWARD



No.	Feed angle	B	φ	T	L	Weight(g)
NBR290	4°	22	13	11	125	110

- The world's highest class 90 gears, 4° feed angle, and 7-step claw precision drive mechanism in a compact head with a 1/4"sq.
  - The push button for easy removal/attachment of sockets and other components is convex in shape to make it easy to push.
  - The lever is 3-dimensionally shaped for easy fingertip access and improved operability.
  - Repair kit (NBR290-K ➔ P.089, NBR290-TK ➔ P.090) are set up.
  - \* Repair parts are set. ➔ Refer to "Repairable List" from P.625.
- Packing unit 1



- To avoid damage or idling, be sure to operate the left and right switching levers securely.

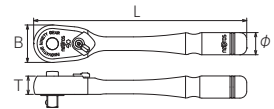

1/4"sq. RATCHET HANDLE (LONG)

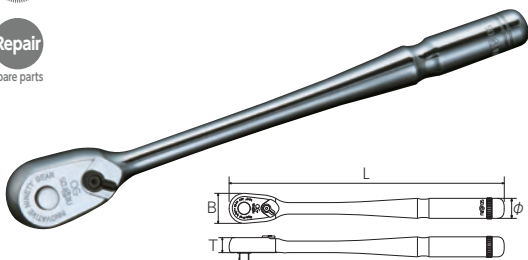

No.	Feed angle	B	φ	T	L	Weight(g)
NBR290L	4°	22	13	11	175	145

- The world's highest class 90 gears, 4° feed angle, and 7-step claw precision drive mechanism in a compact head with a 1/4"sq.
  - The push button for easy attachment and removal of sockets and other components is convex in shape for easy pressing.
  - The lever is 3-dimensionally shaped for easy fingertip access and improved operability.
  - Repair kit (NBR290-K ➔ P.089, NBR290-TK ➔ P.090) are set up.
  - \* Repair parts are set. ➔ Refer to "Repairable List" from P.625.
- Packing unit 1



- To avoid damage or idling, be sure to operate the left and right switching levers securely.
- Be careful of overtorque due to the long overall length and the tendency to apply excessive load.

• Do not use hand tools with an impact wrench.

### 1/4"sq. RATCHET HANDLE (SHORT)

IF DESIGN AWARD



No.	Feed angle	B	φ	T	L	Weight(g)
NBR290S	4°	22	15	11	80	85

- The world's highest class 90 gears, 4° feed angle, and 7-step claw precision drive mechanism in a compact head with a 1/4"sq.
  - The push button for easy attachment and removal of sockets and other components is convex in shape for easy pressing.
  - Repair kit (NBR290-K → P.089, NBR290-TK → P.090) are set up.
  - \* Repair parts are set. → Refer to "Repairable List" from P.625.
- Packing unit 1



• To avoid damage or idling, be sure to operate the left and right switching levers securely.

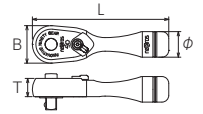

### 1/4"sq. RATCHET HANDLE (FLEX HEAD)

IF DESIGN AWARD

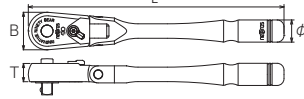
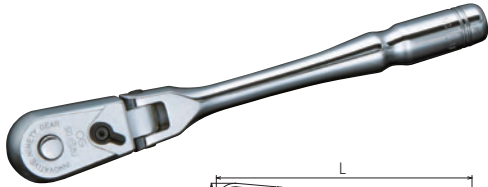

No.	Feed angle	B	φ	T	L	Weight(g)
NBR290F	4°	22	13	11	150	135

- The world's highest class 90 gears, 4° feed angle, and 7-step claw precision drive mechanism in a compact head with a 1/4"sq.
  - The push button for easy attachment and removal of sockets and other components is convex in shape for easy pressing.
  - Repair kit (NBR290-K → P.089, NBR290-TK → P.090) are set up.
  - \* Repair parts are set. → Refer to "Repairable List" from P.625.
- Packing unit 1



• To avoid damage or idling, be sure to operate the left and right switching levers securely.  
 • The flex section of the flex type will become unstable if too much force is applied to the work.

### 1/4"sq. RATCHET HANDLE (FLEX HEAD SHORT)

IF DESIGN AWARD

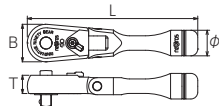
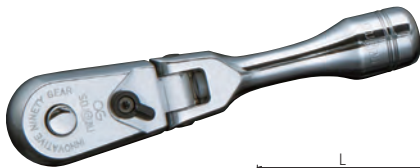

No.	Feed angle	B	φ	T	L	Weight(g)
NBR290FS	4°	22	15	11	100	105

- The world's highest class 90 gears, 4° feed angle, and 7-step claw precision drive mechanism in a compact head with a 1/4"sq.
  - The push button for easy attachment and removal of sockets and other components is convex in shape for easy pressing.
  - The lever is 3-dimensionally shaped for easy fingertip access and improved operability.
  - Repair kit (NBR290-K → P.089, NBR290-TK → P.090) are set up.
  - \* Repair parts are set. → Refer to "Repairable List" from P.625.
- Packing unit 1



• To avoid damage or idling, be sure to operate the left and right switching levers securely.  
 • The flex section of the flex type will become unstable if too much force is applied to the work.

### 1/4"sq. RATCHET HANDLE (STUBBY)

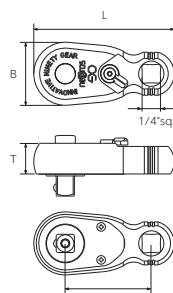

No.	Feed angle	B	T	L	Weight(g)
NBR290H	4°	22	11	49	60

- The drive size is designed with a power-fit shape that prevents stress concentration and contributes to increased strength.
  - Can be used with 1/4"sq. insert angle in combination with a breaker bar, etc.
  - Repair kits (NBR290-K → P.089, NBR290-TK → P.090) are available.
  - \* Repair parts are set. → Refer to "Repairable List" from P.625.
- Packing unit 1



• To avoid damage or idling, be sure to operate the left and right switching levers securely.

### REPAIR KIT FOR 1/4"sq. 90-TOOTH RATCHET HANDLE

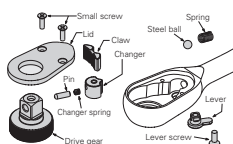

No.	Drive size	Contents	Weight(g)
NBR290-K	1/4"sq.	1 each of drive gear, claw, steel ball, pin, changer, changer spring, spring, lever, screw, lid, and small screw × 2	27

- Applicable to: NBR290, NBR290L, NBR290S, NBR290F, NBR290FS, NBR290H
- \* NBR2UN, NBR2SUN, NBR2FUN, and NBR2FSUN (discontinued product) are not applicable.
- \* A T-shaped Torx wrench (T6) is required to remove and install the lever of the NBR290 series. If you do not have one, please purchase NBR290-TK. → P.090
- \* Cross screwdriver (No.1) is required when replacing the head.

• Function mark is indicated under the product name. For the details, please refer to → P.004-005.  
 • Products marked with → should be ordered after checking stock.



**REPAIR KIT FOR  
1/4"sq. 90-TOOTH RATCHET HANDLE**



No.	Drive size	Contents	Weight(g)
NBR290-TK	1/4"sq.	NBR290-K Contents + T-type Torx L-Handle LT6	27

- Applicable to: NBR290, NBR290L, NBR290S, NBR290F, NBR290FS, NBR290H
- \* NBR2UN, NBR2SUN, NBR2FUN, and NBR2FSUN (discontinued product) are not applicable.
- \* Cross screwdriver (No.1) is required when replacing the head.

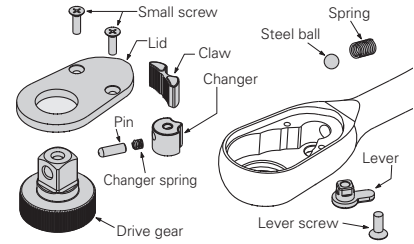

**1/4"sq. BREAKER BAR**



Spare parts

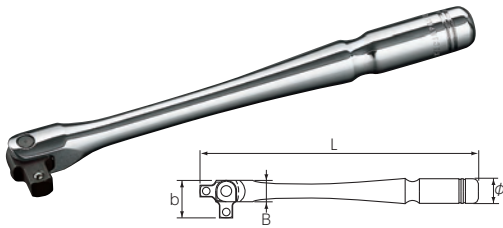

No.	B	b	φ	L	Weight(g)
NBS2	10.5	19.3	13	149.3	100

- \* Repair kit (NBS2-K) is set. P.090
- \* Repair parts are set. Refer to "Repairable List" from P.625.
- Packing unit 5



- Hold the center of the grip as the drive may pinch your hand.
- Be careful of overtorque due to the long overall length and the tendency to apply excessive load.

**1/4"sq. BREAKER BAR (SHORT)**



Spare parts

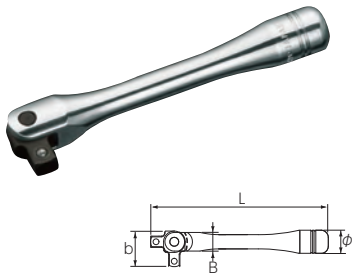

No.	B	b	φ	L	Weight(g)
NBS2S	10.5	19.3	13	97.3	60

- \* Repair kit (NBS2-K) is set. P.090
- \* Repair parts are set. Refer to "Repairable List" from P.625.
- Packing unit 5



- Hold the center of the grip as the drive may pinch your hand.

**1/4"sq. BREAKER BAR (LONG)**



Spare parts

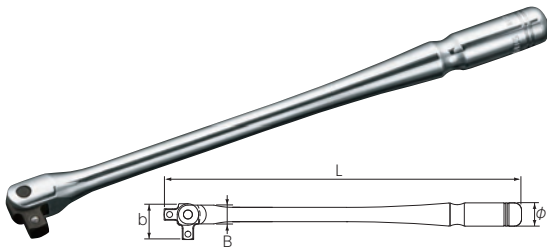

No.	B	b	φ	L	Weight(g)
NBS2L	10.5	19.3	13	199.3	120

- \* Repair kit (NBS2-K) is set. P.090
- \* Repair parts are set. Refer to "Repairable List" from P.625.
- Packing unit 5



- Hold the center of the grip as the drive may pinch your hand.
- Be careful of overtorque due to the long overall length and the tendency to apply excessive load.

**REPAIR KIT FOR  
1/4"sq. BREAKER BAR HEAD**



No.	Drive size	Contents	Weight(g)
NBS2-K	1/4"sq.	Drive head, pin, set screw, plastic pad, spring 1 each	12

- Applicable to: NBS2, NBS2L, NBS2S
- \* A 1.5mm hexagonal wrench is required for head replacement.

Part number NBS2

- This repair kit applies to products with the above part numbers.
- However, only products with an "A" stamped on the breaker bar handle to the right of the above part number will be accepted.
- Please note that this does not apply to products not marked with "A".

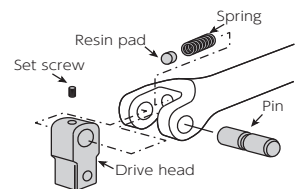

• Do not use hand tools with an impact wrench.



### 1/4"sq. T-SHAPED HANDLE



No.	d	L	ℓ	Weight(g)
NBHT2	7.5	200	140	160

- Compact design with a handle width of 140 mm and a small turning radius for improved workability in tight spaces.
- Weights are placed on both ends of the handle for better balance during rapid turning and improved workability.

Packing unit 5

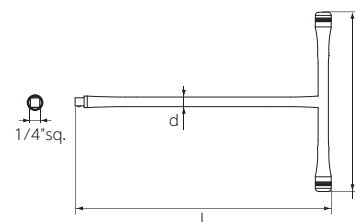

### 1/4"sq. SLIDE HEAD HANDLE



No.	D	d	H	L	Weight(g)
NBHM2	9	7	21	120	70

- The head is spherical and more compact.
- The head moves to the end of the handle so that the tip is less likely to bother. It also has a stop position in the center for improved workability.

Packing unit 5

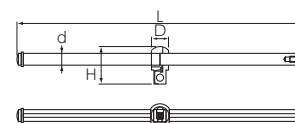

### 1/4"sq. GRIP TYPE HANDLE



No.	D	L	Weight(g)
NBE28	27.4	20.5	35

- This is a special driving tool for fast turning that is more effective when used in combination with a ratchet handle or extension bar. (under light load).
- The rubber ring can be replaced. ➔ P.118-119.

Packing unit 5

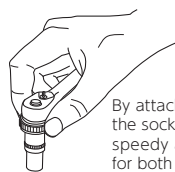

By attaching it between the ratchet handle and the socket, the socket can be turned quickly for speedy and comfortable work. It can be used for both tightening and loosening work.

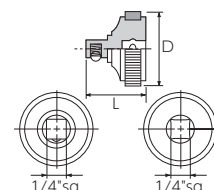

### 1/4"sq. GRIP TYPE HANDLE ADAPTER



No.	sq.		D	L	Weight(g)
	Concave	Convex			
NBAE23	1/4"sq.	3/8"sq.	27.4	22.5	43

- The drive size is designed with a power-fit shape that prevents stress concentration and contributes to increased strength.
- Conversion adapter to enable use of 3/8"sq. sockets with 1/4"sq. ratchets.
- The ratchet can be turned quickly at the same time as the drive angle is converted.
- The rubber ring can be replaced. ➔ P.118-119.

Packing unit 5



The limiting torque of the adapter is based on the 1/4"sq. drive size. Be careful not to apply too much force.

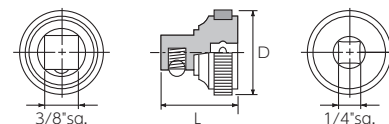

### 1/4"sq. SCREWDRIVER TYPE HANDLE



No.	D	S	ℓ	L	Weight(g)
NBD12	32	8	70	178	105

Packing unit 5

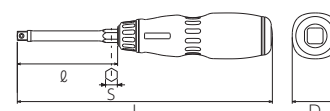

• Function mark is indicated under the product name. For the details, please refer to ➔ P.004-005.  
 • Products marked with ⚠ should be ordered after checking stock.



**1/4"sq. SCREWDRIVER TYPE HANDLE (SHORT)**



No.	D	S	ℓ	L	Weight(g)
NBD12S	32	8	20	128	90

Packing unit 5

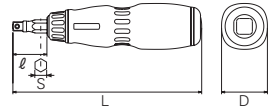

**1/4"sq. SCREWDRIVER TYPE HANDLE (STUBBY)**



No.	D	ℓ	L	Weight(g)
NBD12SS	35	17	62	60

Packing unit 5

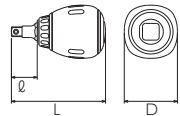

**1/4"sq. EXTENSION BAR SET [4pcs.]**



4 pcs.



No.	Weight(g)
NTBE204	150

Set contents

Extension bar NBE2-025,050,075,150

Packing unit 1



· Do not use more than two connected wires.

**1/4"sq. EXTENSION BAR**

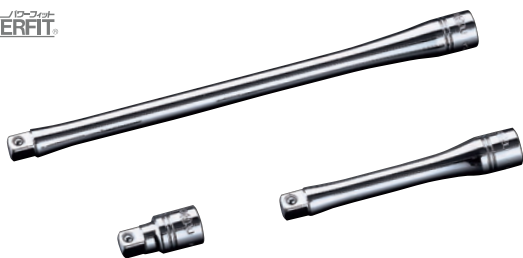

No.	D	L	Weight(g)
NBE2-025	12	25	14
NBE2-050	12	50	26
NBE2-075	12	75	36
NBE2-150	12	150	66

· The streamlined form minimizes deflection.

Packing unit 5



· Do not use more than two connected wires.

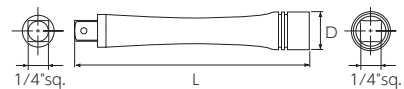

· Do not use hand tools with an impact wrench.

### 1/4"sq. WOBBLE EXTENSION BAR

1/4" sq.

POWERFIT

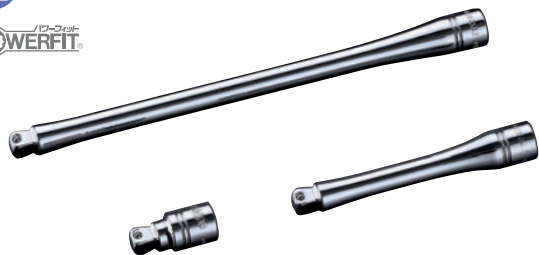

No.	D	L	Weight(g)
NBE2-025JW	12	25	14
NBE2-050JW	12	50	26
NBE2-075JW	12	75	36
NBE2-150JW	12	150	66

- Straight hold mechanism. The socket can be held straight by inserting it deeper than the normal mounting position (flex position).
- The strength in the straight hold state is 30% higher than in the swivel state. Swing angle approx. 13



- Be careful not to exert excessive force, as the load capacity is lower than that of a normal extension bar due to its structure.
- Do not use more than two connected wires.

**Straight hold mechanism**

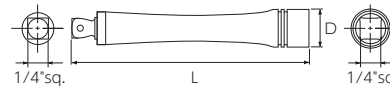
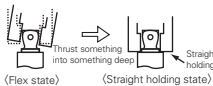

### 1/4"sq. UNIVERSAL JOINT

1/4" sq.

POWERFIT



No.	D	L	Weight(g)
NBJ2	13	29.5	20

- The GRANDCROSS mechanism with two rotating shafts on the same axis provides smooth movement and excellent torque transmission, which nepros is proud of.
- The overall length is only 29.5mm, 4.5mm shorter than the conventional product.
- The high-strength design with suppressed mouth opening and high-grade spring washers have improved pivoting retention and durability.



- The joint part is vulnerable to impact and pry, so be careful not to exert excessive force.

**GRANDCROSS mechanism**

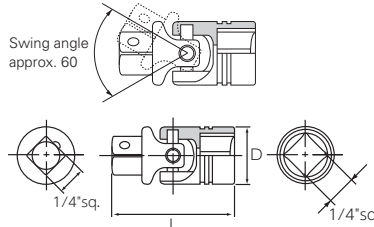
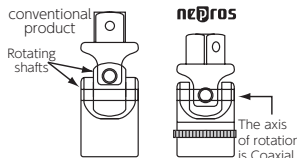

### 1/4"sq. SOCKET ADAPTER

1/4" sq.

3/8" sq.

POWERFIT



No.	sq.		D	L	Weight(g)
	Concave	Convex			
NBA23	1/4"	3/8"	13	22	16

Packing unit 5



- The limiting torque of the adapter is based on the smaller drive size. Be careful not to apply too much force.

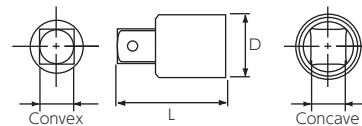

### 1/4"sq. SOCKET HOLDER

1/4" sq.

Repair

Spare parts

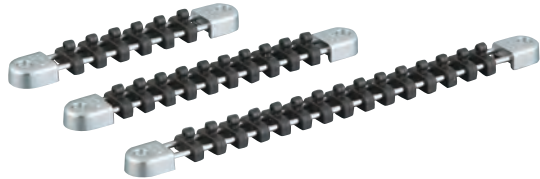

No.	Number of clips	H	A	L	Weight(g)
NEHB206	6	19	25	169	95
NEHB210	10	19	25	219	106
NEHB215	15	19	25	319	120

Packing unit 5



- The socket holder may fall out if the socket holder is turned upside down.

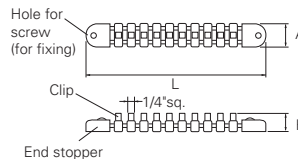

**Spare parts**

No.	Weight(g)
NTEHB205	Spare clip set for 1/4"sq. socket holder 5 pcs. 11

- Spare clip for NEHB206, NEHB210 and NEHB215.
- Also available for NEHB306-315(3/8"sq.), 406-410(1/2"sq.).

Packing unit 5

· Function mark is indicated under the product name. For the details, please refer to P.004-005.  
 · Products marked with should be ordered after checking stock.



3/8"sq. SOCKET WRENCH SET [26pcs.]

3/8" sq.

26 pcs.

90

6pt.

POWERFIT



No.	Weight(kg)
NTB3X26C	2.3
Set contents	
Sockets (6pt.)	NB3-055,07,08,10,12,13,14,17,19,21,22,24
Deep sockets (6pt.)	NB3L-08,10,12,13,14,17
Ratchet handle	NBR390A
Breaker bar	NBS3
Quick spinner	NBE38
Extension bar	NBE3-050,075,150,300
Universal joint	NBJ3
Tray (W447×D185×H30)	NTB3X26C-TR

- NTB3X26CZ without case.
  - The tray is set to fit into the NEKB-2 metal case (P.097).
  - The rubber ring can be replaced. (P.118-119).
- Packing unit 1

3/8"sq. SOCKET WRENCH SET [26pcs.]

3/8" sq.

26 pcs.

90

6pt.

POWERFIT



No.	Weight(kg)
NTB3X26CZ	3.9
Set contents	
Sockets (6pt.)	NB3-055,07,08,10,12,13,14,17,19,21,22,24
Deep sockets (6pt.)	NB3L-08,10,12,13,14,17
Ratchet handle	NBR390A
Breaker bar	NBS3
Quick spinner	NBE38
Extension bar	NBE3-050,075,150,300
Universal joint	NBJ3
Metal case (W455×D190×H60)	NEKB-2
Tray (W447×D185×H30)	NTB3X26C-TR

- This model is NTB3X26C with case. (The case is shown on P.097).
  - The rubber ring can be replaced. (P.118-119).
- Packing unit 1

3/8"sq. SOCKET WRENCH SET [17pcs.]

3/8" sq.

17 pcs.

90

6pt.

POWERFIT



No.	Weight(kg)
NTB317C	1.6
Set contents	
Sockets (6pt.)	NB3-055,07,08,10,12,13,14,17,19,21,22,24
Ratchet handle	NBR390A
Breaker bar	NBS3
Extension bar	NBE3-075,150
Universal joint	NBJ3
Tray (W447×D185×H30)	NTB317C-TR

- This is a model of NTB317CZ without a case.
  - The tray is set to fit into the NEKB-2 metal case (P.097).
  - The rubber ring can be replaced. (P.118-119).
- Packing unit 1

3/8"sq. SOCKET WRENCH SET [17pcs.]

3/8" sq.

17 pcs.

90

6pt.

POWERFIT



No.	Weight(kg)
NTB317CZ	3.2
Set contents	
Sockets (6pt.)	NB3-055,07,08,10,12,13,14,17,19,21,22,24
Ratchet handle	NBR390A
Breaker bar	NBS3
Extension bar	NBE3-075,150
Universal joint	NBJ3
Metal case (W455×D190×H60)	NEKB-2
Tray (W447×D185×H30)	NTB317C-TR

- This model is NTB317C with case. (The case is shown on P.097).
  - The rubber ring can be replaced. (P.118-119).
- Packing unit 1

· Do not use hand tools with an impact wrench.

### 3/8"sq. SOCKET WRENCH SET [17pcs.]

3/8" sq.

17 pcs.

90

6pt.

12pt.

POWERFIT



No.	Weight(kg)
NTB317XC	1.6
Set contents	
Sockets (6pt.)	NB3-055,07,08,10,12,13,14
Sockets (12pt.)	NB3-17W,19W,21W,22W,24W
Ratchet handle	NBR390A
Breaker bar	NBS3
Extension bar	NBE3-075,150
Universal joint	NBJ3
Tray (W447×D185×H30)	NTB317C-TR

- This is a model of NTB317XCZ without a case.
- The tray is set to fit into the NEKB-2 metal case ( P.097).
- The rubber ring can be replaced. P.118-119.

Packing unit 1

### 3/8"sq. SOCKET WRENCH SET [17pcs.]

3/8" sq.

17 pcs.

90

6pt.

12pt.

POWERFIT



No.	Weight(kg)
NTB317XCZ	3.2
Set contents	
Sockets (6pt.)	NB3-055,07,08,10,12,13,14
Sockets (12pt.)	NB3-17W,19W,21W,22W,24W
Ratchet handle	NBR390A
Breaker bar	NBS3
Extension bar	NBE3-075,150
Universal joint	NBJ3
Metal case (W455×D190×H60)	NEKB-2
Tray (W447×D185×H30)	NTB317C-TR

- This model is NTB317XC with case. The case is shown on P.097.
- The rubber ring can be replaced. P.118-119.

Packing unit 1

### 3/8"sq. SOCKET WRENCH SET [11pcs.]

3/8" sq.

11 pcs.

90

6pt.

POWERFIT



No.	Weight(kg)
NTB311C	0.9
Set contents	
Sockets (6pt.)	NB3-08,10,12,13,14,17,19
Ratchet handle	NBR390A
Extension bar	NBE3-075,150
Universal joint	NBJ3
Tray (W267×D145×H30)	NTB311C-TR

- NTB311CZ without case.
- The tray is set to fit into the NEKB-1 metal case ( P.097).
- The rubber ring can be replaced. P.118-119.

Packing unit 1

### 3/8"sq. SOCKET WRENCH SET [11pcs.]

3/8" sq.

11 pcs.

90

6pt.

POWERFIT



No.	Weight(kg)
NTB311CZ	1.7
Set contents	
Sockets (6pt.)	NB3-08,10,12,13,14,17,19
Ratchet handle	NBR390A
Extension bar	NBE3-075,150
Universal joint	NBJ3
Metal case (W275×D150×H50)	NEKB-1
Tray (W267×D145×H30)	NTB311C-TR

- This model is NTB311C with a case. The case is shown on P.097.
- The rubber ring can be replaced. P.118-119.

Packing unit 1

• Function mark is indicated under the product name. For the details, please refer to P.004-005.  
 • Products marked with should be ordered after checking stock.





3/8"sq. SOCKET WRENCH SET [11pcs.]

3/8" sq.

inch

11 pcs.

90

6pt.



No.	Weight(g)
NTB311BC	900
Set contents	
Sockets (6pt.)	NB3-5/16,3/8,7/16,1/2,9/16,5/8,11/16
Ratchet handle	NBR390A
Extension bar	NBE3-075,150
Universal joint	NBJ3
Tray (W267×D145×H30)	NTB311C-TR

- This is a model of NTB311BCZ without a case.
- The tray is set to fit into the NEKB-1 metal case ( P.097).
- The rubber ring can be replaced. P.118-119.

Packing unit 1

3/8"sq. SOCKET WRENCH SET [11pcs.]

3/8" sq.

inch

11 pcs.

90

6pt.



No.	Weight(kg)
NTB311BCZ	1.7
Set contents	
Sockets (6pt.)	NB3-5/16,3/8,7/16,1/2,9/16,5/8,11/16
Ratchet handle	NBR390A
Extension bar	NBE3-075,150
Universal joint	NBJ3
Metal case (W275×D150×H50)	NEKB-1
Tray (W267×D145×H30)	NTB311C-TR

- This is a model of NTB311BC with a case. The case is shown on P.097.
- The rubber ring can be replaced. P.118-119.

Packing unit 1

3/8"sq. DEEP SOCKET WRENCH SET [10pcs.]

3/8" sq.

10 pcs.

90

6pt.



No.	Weight(kg)
NTB3L10C	1.1
Set contents	
Deep sockets (6pt.)	NB3L-08,10,12,13,14,17
Ratchet handle	NBR390A
Extension bar	NBE3-075,150
Universal joint	NBJ3
Tray (W267×D145×H30)	NTB3L10C-TR

- NTB3L10CZ without case.
- The tray is set to fit into the NEKB-1 metal case ( P.097).
- The rubber ring can be replaced. P.118-119.

Packing unit 1

3/8"sq. DEEP SOCKET WRENCH SET [10pcs.]

3/8" sq.

10 pcs.

90

6pt.



No.	Weight(kg)
NTB3L10CZ	1.9
Set contents	
Deep sockets (6pt.)	NB3L-08,10,12,13,14,17
Ratchet handle	NBR390A
Extension bar	NBE3-075,150
Universal joint	NBJ3
Metal case (W275×D150×H50)	NEKB-1
Tray (W267×D145×H30)	NTB3L10C-TR

- This model is NTB3L10C with a case. The case is shown on P.097.
- The rubber ring can be replaced. P.118-119.

Packing unit 1

• Do not use hand tools with an impact wrench.

METAL CASE



No.	Body size	Weight(g)
NEKB-1	W275×D150×H50	800

· Convenient for management of tools and parts.  
 · Material is steel.  
 Packing unit 1

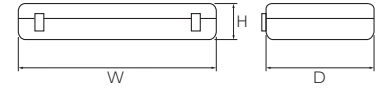

METAL CASE



No.	Body size	Weight(kg)
NEKB-2	W455×D190×H60	1.6

· The case is with a handle in the shape of a trunk.  
 · Convenient for management of tools and parts.  
 · Material is steel.  
 Packing unit 1

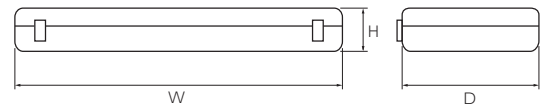

3/8"sq. SOCKET SET [6pcs.]



No.	Weight(g)
NTB306A	300

Set contents	
Sockets (6pt.)	NB3-08,10,12,13,14,17
Socket holder for 6 sockets	NEHB306

· Socket set in a nepros 3/8"sq. socket holder.  
 · The rubber ring can be replaced. ➔ P.118-119.  
 Packing unit 1

3/8"sq. SOCKET SET [12pcs.]



No.	Weight(g)
NTB312A	700

Set contents	
Sockets (6pt.)	NB3-055,07,08,10,12,13,14,17,19,21,22,24
Socket holder for 15 sockets	NEHB315

· Socket set in a nepros 3/8"sq. socket holder.  
 · The rubber ring can be replaced. ➔ P.118-119.  
 Packing unit 1

3/8"sq. SOCKET SET [20pcs.]



No.	Weight(kg)
NTB320A	1.1

Set contents	
Sockets (6pt.)	NB3-055,06,07,08,09,10,11,12,13,14,15,16,17,18,19,20,21,22,23,24
Socket holder for 10 sockets	NEHB310 (2 pcs)

· Socket set in a nepros 3/8"sq. socket holder.  
 · The rubber ring can be replaced. ➔ P.118-119.  
 Packing unit 1

· Function mark is indicated under the product name. For the details, please refer to ➔ P.004-005.  
 · Products marked with ⚠ should be ordered after checking stock.



3/8"sq. SOCKET SET [12pcs.]



No.	Weight(g)
NTB312XA	700
Set contents	
Sockets (6pt.)	NB3-055,07,08,10,12,13,14
Sockets (12pt.)	NB3-17W,19W,21W,22W,24W
Socket holder for 15 sockets	NEHB315

· Socket set in a nepros 3/8"sq. socket holder.  
 · The rubber ring can be replaced. P.118-119.  
 Packing unit 1

3/8"sq. SOCKET SET [6pcs.]



No.	Weight(g)
NTB306WA	300
Set contents	
Sockets (12pt.)	NB3-08W,10W,12W,13W,14W,17W
Socket holder for 6 sockets	NEHB306

· Socket set in a nepros 3/8"sq. socket holder.  
 · The rubber ring can be replaced. P.118-119.  
 Packing unit 1

3/8"sq. SOCKET

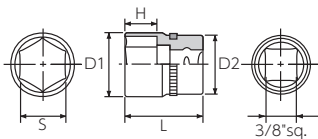

No.	S	D1	D2	H	L	Weight(g)
NB3-055	5.5	8.7	17	5	22	18
NB3-06	6	9.3	17	5	22	18
NB3-07	7	10.3	17	5	22	18
NB3-08	8	11.5	17	5.5	22	18
NB3-09	9	12.8	17	5.5	22	18
NB3-10	10	14	17	5.5	22	18
NB3-11	11	15.2	17	6	23	20
NB3-12	12	16.5	17	7.5	24	22
NB3-13	13	18	17	7.5	24	22
NB3-14	14	19	18	8.5	25	28
NB3-15	15	20.2	18	8.5	26	30
NB3-16	16	21.5	19.5	9	26	35
NB3-17	17	22.7	20.5	10	27	40
NB3-18	18	24	22	10	27	50
NB3-19	19	25	23	10.5	27	52
NB3-20	20	26.2	24	11	28	60
NB3-21	21	27.5	25.5	11.5	28	70
NB3-22	22	28.5	26.5	11.5	28	75
NB3-23	23	29.8	27.5	12	29	85
NB3-24	24	31	29	12	29	90

· The rubber ring can be replaced. P.118-119.  
 Packing unit 5

3/8"sq. SOCKET

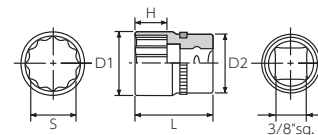

No.	S	D1	D2	H	L	Weight(g)
NB3-08W	8	11.5	17	5.5	22	18
NB3-10W	10	14	17	5.5	22	18
NB3-12W	12	16.5	17	7.5	24	20
NB3-13W	13	18	17	7.5	24	20
NB3-14W	14	19	18	8.5	25	26
NB3-15W	15	20.2	18	8.5	26	28
NB3-16W	16	21.5	19.5	9	26	32
NB3-17W	17	22.7	20.5	10	27	40
NB3-18W	18	24	22	10	27	46
NB3-19W	19	25	23	10.5	27	50
NB3-21W	21	27.5	25.5	11.5	28	66
NB3-22W	22	28.5	26.5	11.5	28	72
NB3-24W	24	31	29	12	29	85

· The rubber ring can be replaced. P.118-119.  
 Packing unit 5

· Do not use hand tools with an impact wrench.

### 3/8"sq. SOCKET SET [6pcs.]



No.	Weight(g)
NTB306BA	300
Set contents	
Sockets (6pt.)	NB3-3/8,7/16,1/2,9/16,5/8,11/16
Socket holder for 6 sockets	NEHB306
<ul style="list-style-type: none"> <li>Socket set in a nepros 3/8"sq. socket holder.</li> <li>The rubber ring can be replaced. P.118-119.</li> </ul>	
Packing unit 1	

### 3/8"sq. SOCKET SET [15pcs.]



No.	Weight(kg)
NTB315BA	1
Set contents	
Sockets (6pt.)	NB3-1/4,5/16,11/32,3/8,7/16,1/2,9/16,19/32,5/8,11/16,3/4,13/16,7/8,15/16,1
Socket holder for 6 or 10 sockets	NEHB306,310
<ul style="list-style-type: none"> <li>Socket set in a nepros 3/8"sq. socket holder.</li> <li>The rubber ring can be replaced. P.118-119.</li> </ul>	
Packing unit 1	

### 3/8"sq. SOCKET

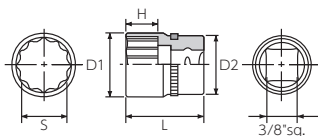

No.	S(in)	D1	D2	H	L	Weight(g)
NB3-1/4	1/4	9.6	17	5	22	18
NB3-5/16	5/16	11.5	17	5.5	22	18
NB3-11/32	11/32	12.4	17	5.5	22	18
NB3-3/8	3/8	13.4	17	5.5	22	18
NB3-7/16	7/16	15.3	17	6	23	20
NB3-1/2	1/2	17.6	17	7.5	24	22
NB3-9/16	9/16	19.4	18	8.5	25	30
NB3-19/32	19/32	20.3	18	8.5	26	40
NB3-5/8	5/8	21.3	19.5	9	26	40
NB3-11/16	11/16	23.3	21	10	27	50
NB3-3/4	3/4	25	23	10.5	27	52
NB3-13/16	13/16	27	25	11.5	28	60
NB3-7/8	7/8	28.8	26.5	11.5	28	75
NB3-15/16	15/16	30.8	29	12	29	90
NB3-1	1	32.7	29	13	30	100

The rubber ring can be replaced. P.118-119.  
Packing unit 5

### 3/8"sq. SOCKET

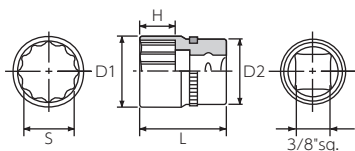

No.	S(in)	D1	D2	H	L	Weight(g)
NB3-1/4W	1/4	9.6	17	5	22	18
NB3-5/16W	5/16	11.5	17	5.5	22	18
NB3-11/32W	11/32	12.4	17	5.5	22	18
NB3-3/8W	3/8	13.4	17	5.5	22	18
NB3-7/16W	7/16	15.3	17	6	23	19
NB3-1/2W	1/2	17.6	17	7.5	24	20
NB3-9/16W	9/16	19.4	18	8.5	25	27
NB3-19/32W	19/32	20.3	18	8.5	26	29
NB3-5/8W	5/8	21.3	19.5	9	26	33
NB3-11/16W	11/16	23.3	21	10	27	42
NB3-3/4W	3/4	25	23	10.5	27	50
NB3-13/16W	13/16	27	25	11.5	28	61
NB3-7/8W	7/8	28.8	26.5	11.5	28	69
NB3-15/16W	15/16	30.8	29	12	29	87
NB3-1W	1	32.7	29	13	30	102

The rubber ring can be replaced. P.118-119.  
Packing unit 5

Function mark is indicated under the product name. For the details, please refer to P.004-005.  
Products marked with should be ordered after checking stock.



3/8"sq. SEMI DEEP SOCKET SET [6pcs.]

3/8" sq. 6 pcs.



POWERFIT



No.	Weight(g)
NTB3M06A	400
Set contents	
Semi-deep sockets (6pt.)	NB3M-08,10,12,13,14,17
Socket holder for 6 sockets	NEHB306

· Socket set in a nepros 3/8"sq. socket holder.  
 · The rubber ring can be replaced. P.118-119.  
 Packing unit 1

3/8"sq. SEMI DEEP SOCKET SET [12pcs.]

3/8" sq. 12 pcs.



POWERFIT



No.	Weight(g)
NTB3M12A	800
Set contents	
Semi-deep sockets (6pt.)	NB3M-08,09,10,11,12,13,14,15,16,17,18,19
Socket holder for 15 sockets	NEHB315

· Socket set in a nepros 3/8"sq. socket holder.  
 · The rubber ring can be replaced. P.118-119.  
 Packing unit 1

3/8"sq. SEMI DEEP SOCKET SET [6pcs.]

3/8" sq. 6 pcs.



POWERFIT



No.	Weight(g)
NTB3M06WA	400
Set contents	
Semi-deep sockets (12pt.)	NB3M-08W,10W,12W,13W,14W,17W
Socket holder for 6 sockets	NEHB306

· Socket set in a nepros 3/8"sq. socket holder.  
 · The rubber ring can be replaced. P.118-119.  
 Packing unit 1

3/8"sq. SEMI DEEP SOCKET

3/8" sq.



POWERFIT

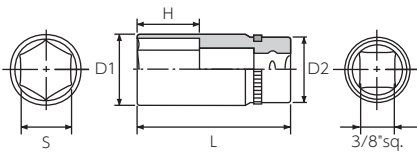

No.	S	D1	D2	H	L	Weight(g)
NB3M-055	5.5	8.7	17	5	35	24
NB3M-06	6	9.3	17	5	35	25
NB3M-07	7	10.3	17	5	35	25
NB3M-08	8	11.5	17	5.5	35	26
NB3M-09	9	12.8	17	5.5	35	28
NB3M-10	10	14	17	5.5	35	29
NB3M-11	11	15.2	17	6	35	31
NB3M-12	12	16.5	17	7.5	35	33
NB3M-13	13	18	17	7.5	40	42
NB3M-14	14	19	18	8.5	40	49
NB3M-15	15	20.2	18	8.5	40	51
NB3M-16	16	21.5	19.5	9	40	60
NB3M-17	17	22.7	20.5	10	40	65
NB3M-18	18	24	22	10	40	75
NB3M-19	19	25	23	10.5	40	80

· The rubber ring can be replaced. P.118-119.  
 Packing unit 5

3/8"sq. SEMI DEEP SOCKET

3/8" sq.



POWERFIT

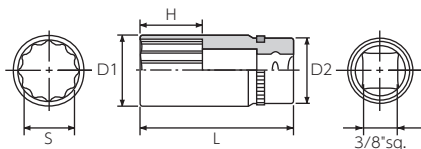

No.	S	D1	D2	H	L	Weight(g)
NB3M-08W	8	11.5	17	5.5	35	26
NB3M-10W	10	14	17	5.5	35	29
NB3M-12W	12	16.5	17	7.5	35	33
NB3M-13W	13	18	17	7.5	40	42
NB3M-14W	14	19	18	8.5	40	49
NB3M-15W	15	20.2	18	8.5	40	51
NB3M-16W	16	21.5	19.5	9	40	60
NB3M-17W	17	22.7	20.5	10	40	65
NB3M-18W	18	24	22	10	40	75
NB3M-19W	19	25	23	10.5	40	80

· The rubber ring can be replaced. P.118-119.  
 Packing unit 5

· Do not use hand tools with an impact wrench.



3/8"sq. SEMI DEEP SOCKET



inch



POWERFIT



No.	S	D1	D2	H	L	Weight(g)
NB3M-1/4	1/4	9.6	17	5	35	27
NB3M-5/16	5/16	11.5	17	5.5	35	28
NB3M-11/32	11/32	12.4	17	5.5	35	29
NB3M-3/8	3/8	13.4	17	5.5	35	30
NB3M-7/16	7/16	15.3	17	6	35	32
NB3M-1/2	1/2	17.6	17	7.5	35	37
NB3M-9/16	9/16	19.4	18	8.5	40	52
NB3M-5/8	5/8	21.3	19.5	9	40	59
NB3M-11/16	11/16	23.3	21	10	40	71

• The rubber ring can be replaced. ➔ P.118-119.  
Packing unit 5

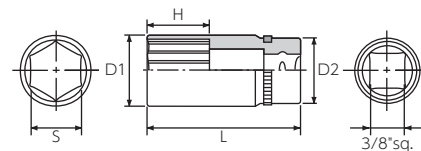

3/8"sq. SEMI DEEP SOCKET



inch



POWERFIT



No.	S	D1	D2	H	L	Weight(g)
NB3M-1/4W	1/4	9.6	17	5	35	27
NB3M-5/16W	5/16	11.5	17	5.5	35	28
NB3M-11/32W	11/32	12.4	17	5.5	35	29
NB3M-3/8W	3/8	13.4	17	5.5	35	30
NB3M-7/16W	7/16	15.3	17	6	35	31
NB3M-1/2W	1/2	17.6	17	7.5	35	41
NB3M-9/16W	9/16	19.4	18	8.5	40	50
NB3M-5/8W	5/8	21.3	19.5	9	40	58
NB3M-11/16W	11/16	23.3	21	10	40	64

• The rubber ring can be replaced. ➔ P.118-119.  
Packing unit 5

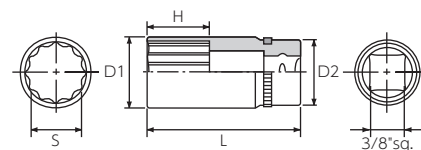

3/8"sq. DEEP SOCKET SET [6pcs.]



6 pcs.



POWERFIT



No.	Weight(g)
NTB3L06A	500

Set contents	
Deep sockets (6pt.)	NB3L-08,10,12,13,14,17
Socket holder for 6 sockets	NEHB306

• Socket set in a nepros 3/8"sq. socket holder.  
• The rubber ring can be replaced. ➔ P.118-119.  
Packing unit 1

3/8"sq. DEEP SOCKET SET [12pcs.]



12 pcs.



POWERFIT



No.	Weight(kg)
NTB3L12A	1.2

Set contents	
Deep sockets (6pt.)	NB3L-055,07,08,10,12,13,14,17,19,21,22,24
Socket holder for 15 sockets	NEHB315

• Socket set in a nepros 3/8"sq. socket holder.  
• The rubber ring can be replaced. ➔ P.118-119.  
Packing unit 1

• Function mark is indicated under the product name. For the details, please refer to ➔ P.004-005.  
• Products marked with ⚠ should be ordered after checking stock.



3/8"sq. DEEP SOCKET SET [12pcs.]



No.	Weight(kg)
NTB3L12XA	1.2
Set contents	
Deep sockets (6pt.)	NB3L-055,07,08,10,12,13,14
Deep socket (12pt.)	NB3L-17W,19W,21W,22W,24W
Socket holder for 15 sockets	NEHB315

- Socket set in a nepros 3/8"sq. socket holder.
- The rubber ring can be replaced. ● P.118-119.

Packing unit 1

3/8"sq. DEEP SOCKET SET [6pcs.]



No.	Weight(g)
NTB3L06WA	500
Set contents	
Deep socket (12pt.)	NB3L-08W,10W,12W,13W,14W,17W
Socket holder for 6 sockets	NEHB306

- Socket set in a nepros 3/8"sq. socket holder.
- The rubber ring can be replaced. ● P.118-119.

Packing unit 1

3/8"sq. DEEP SOCKET

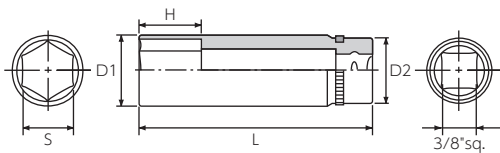

No.	S	D1	D2	H	L	Weight(g)
NB3L-055	5.5	8.7	17	6	55	32
NB3L-06	6	9.3	17	6	55	33
NB3L-07	7	10.3	17	8	55	34
NB3L-08	8	11.5	17	9	55	36
NB3L-09	9	12.8	17	10	55	38
NB3L-10	10	14	17	11	55	42
NB3L-11	11	15.2	17	12	55	46
NB3L-12	12	16.5	17	14	55	48
NB3L-13	13	18	17	14	60	60
NB3L-14	14	19	18	17	60	70
NB3L-15	15	20.2	18	17	60	75
NB3L-16	16	21.5	19.5	17	60	85
NB3L-17	17	22.7	20.5	17	60	95
NB3L-18	18	24	22	21	60	105
NB3L-19	19	25	23	21	60	110
NB3L-21	21	27.5	25.5	23	65	145
NB3L-22	22	28.5	26.5	23	65	160
NB3L-24	24	31	29	27	65	180

- The rubber ring can be replaced. ● P.118-119.

Packing unit 5

3/8"sq. DEEP SOCKET

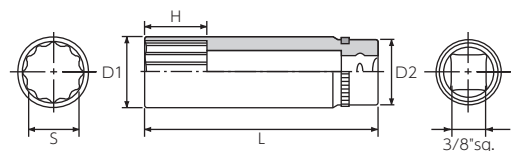

No.	S	D1	D2	H	L	Weight(g)
NB3L-08W	8	11.5	17	9	55	40
NB3L-10W	10	14	17	11	55	40
NB3L-12W	12	16.5	17	14	55	45
NB3L-13W	13	18	17	14	60	60
NB3L-14W	14	19	18	17	60	70
NB3L-17W	17	22.7	20.5	17	60	90
NB3L-19W	19	25	23	21	60	105
NB3L-21W	21	27.5	25.5	23	65	140
NB3L-22W	22	28.5	26.5	23	65	150
NB3L-24W	24	31	29	27	65	170

- The rubber ring can be replaced. ● P.118-119.

Packing unit 5

· Do not use hand tools with an impact wrench.

3/8"sq. DEEP SOCKET



inch



POWERFIT



No.	S(in)	D1	D2	H	L	Weight(g)
NB3L-1/4	1/4	9.6	17	6	55	34
NB3L-5/16	5/16	11.5	17	9	55	37
NB3L-11/32	11/32	12.4	17	10	55	39
NB3L-3/8	3/8	13.4	17	11	55	41
NB3L-7/16	7/16	15.3	17	12	55	46
NB3L-1/2	1/2	17.6	17	14	60	56
NB3L-9/16	9/16	19.4	18	17	60	75
NB3L-5/8	5/8	21.3	19.5	17	60	85
NB3L-11/16	11/16	23.3	21	21	60	101
NB3L-3/4	3/4	25	23	21	60	113
NB3L-13/16	13/16	27	25	23	65	143
NB3L-7/8	7/8	28.8	26.5	23	65	160
NB3L-15/16	15/16	30.8	29	27	65	184

• The rubber ring can be replaced. P.118-119.  
Packing unit 5

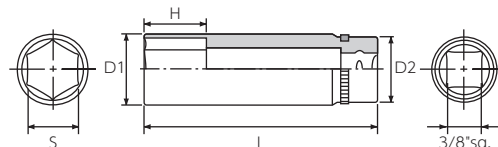

3/8"sq. DEEP SOCKET



inch



POWERFIT



No.	S(in)	D1	D2	H	L	Weight(g)
NB3L-1/4W	1/4	9.6	17	6	55	34
NB3L-5/16W	5/16	11.5	17	9	55	36
NB3L-11/32W	11/32	12.4	17	10	55	39
NB3L-3/8W	3/8	13.4	17	11	55	40
NB3L-7/16W	7/16	15.3	17	12	55	45
NB3L-1/2W	1/2	17.6	17	14	60	54
NB3L-9/16W	9/16	19.4	18	17	60	73
NB3L-5/8W	5/8	21.3	19.5	17	60	83
NB3L-11/16W	11/16	23.3	21	21	60	98
NB3L-3/4W	3/4	25	23	21	60	109
NB3L-13/16W	13/16	27	25	23	65	138
NB3L-7/8W	7/8	28.8	26.5	23	65	154
NB3L-15/16W	15/16	30.8	29	27	65	175

• The rubber ring can be replaced. P.118-119.  
Packing unit 5



3/8"sq. SPARK PLUG SOCKET WRENCH SET [5pcs.]



5 pcs.



POWERFIT



No.	Weight(g)
NTB305SPA	560

Set contents	
Plug wrench	NB3-13SP,14SP,16SP,18SP,208SP
Socket holder for 6 sockets	NEHB306

- Slim design made possible by advanced technology. Compact in height and outer diameter.
- The shape of the socket is close to that of a spark plug, making it effective in confined and tight spaces.
- Hexagonal shaped drive part unified to 17mm, easy to work with a wrench or Box end wrench. (Excluding NB3-13SP and 14SP)
- It is equipped with a magnet for working even in deep places.
- The rubber ring can be replaced.

P.118-119.  
Packing unit 1



Slim shape close to a spark plug

• Function mark is indicated under the product name. For the details, please refer to P.004-005.  
• Products marked with should be ordered after checking stock.



### 3/8"sq. SPARK PLUG SOCKET WRENCH



No.	S1	S2	D	H	L	Weight(g)
NB3-13SP	13	—	18	8	51	55
NB3-14SP	14	—	18.5	7	62	60
NB3-16SP	16	17	20.7	6	60	75
NB3-18SP	18	17	23	6	58	85
NB3-208SP	20.8	17	26.3	8	60	110

· The rubber ring can be replaced. P.118-119.  
Packing unit 5

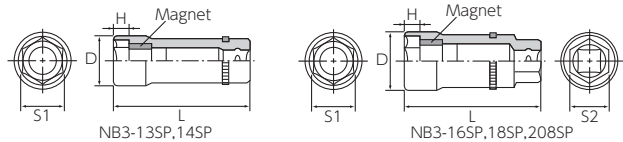

### 3/8"sq. CROWFOOT WRENCH SET [7pcs.]



No.	Weight(g)
NTBNS307	400

Set contents	
Crowfoot wrench	NBNS3-08,10,12,13,14,17,19

- Power-fit shape for hexagonal flare nuts.
- The aperture is angled at 15° and can be used in a 30° range by using both sides of the aperture, making it effective in tight spaces.
- The common size of the drive angle center distance (20 mm for NBNS3-08 to 13 and 25 mm for NBNS3-14 to 19) from the center of the bore makes it easy to calculate when combined with a torque wrench.

Packing unit 1

### 3/8"sq. CROWFOOT WRENCH



No.	S	W	T	L	B	Weight(g)
NBNS3-08	8	18	9.5	35	20	30
NBNS3-10	10	21.5	9.5	36.8	20	35
NBNS3-12	12	26	10	38.6	20	40
NBNS3-13	13	26	10	38.6	20	40
NBNS3-14	14	29	11	45.7	25	60
NBNS3-17	17	35	13	48.4	25	85
NBNS3-19	19	35	13	48.4	25	85

Packing unit 5

Input value conversion method when using a torque wrench

$$\frac{\text{Effective length of torque wrench}}{\text{Torque wrench Effective length} + \text{Extended effective length (dimension B in the figure)}} \times \text{Target torque value} = \text{Input torque value}$$

- \* Effective length of torque wrench: Distance from the center of the bolt to the force point (usually the center of the grip)
- \* Target torque value: Torque value to be tightened
- \* Input torque: Torque value to be set on the torque wrench P.408.

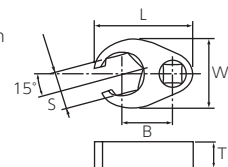

· Do not use hand tools with an impact wrench.

### 3/8"sq. WOBBLE SOCKET SET [5pcs.]



No.	Weight(g)
NTB305JUA	400
Set contents	
Universal Socket	NB3-08JU,10JU,12JU,13JU,14JU
Socket holder for 6 sockets	NEHB306

- Universal socket set in a nepros 3/8"sq. socket holder.
  - The length between the fulcrum pin and the end of the socket is shorter, approximately 4 to 6 mm shorter than the combined length of the socket and universal joint.
  - The two rotating shafts are coaxial in the GRANDCROSS mechanism for smooth movement and excellent torque transmission.
  - The rubber ring can be replaced. ➔ P.118-119.
- Packing unit 1



· The joint part is vulnerable to impact and pry, so be careful not to exert excessive force.

### 3/8"sq. UNIVERSAL SOCKET



No.	S(6pt.)	D1	D2	H	L	Weight(g)
NB3-08JU	8	11.5	19	5.5	36.5	40
NB3-10JU	10	14	19	5.5	36.5	45
NB3-12JU	12	16.5	19	7.5	38.5	50
NB3-13JU	13	17.3	19	7.5	38.5	50
NB3-14JU	14	18.4	19	8.5	39.5	55

- The rubber ring can be replaced. ➔ P.118-119.
- Packing unit 5



· The joint part is vulnerable to impact and pry, so be careful not to exert excessive force.

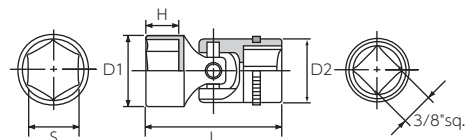

### 3/8"sq. HEX. BIT SOCKET SET [6pcs.]

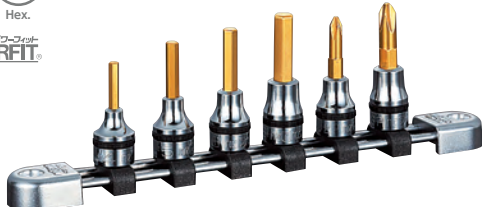

No.	Weight(g)
NTBT306A	300
Set contents	
Hexagonal bit socket	NBT3-04,05,06,08
Cross bit socket	NBT3P-2,3
Socket holder for 6 sockets	NEHB306

- Bit socket set in a nepros 3/8"sq. socket holder.
  - TiN (titanium) coating improves abrasion resistance.
  - The rubber ring can be replaced. ➔ P.118-119.
  - \* The TiN coating on the bit is not intended to prevent rust. Please take care of the bits by applying oil, etc.
- Packing unit 1

### 3/8"sq. HEX. BIT SOCKET

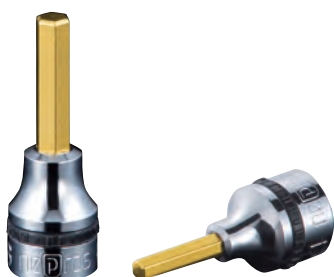

No.	S	D	L	ℓ	Weight(g)
NBT3-04	4	17	42	19	20
NBT3-05	5	17	48	23	25
NBT3-06	6	17	51	26	30
NBT3-08	8	17	55	28	40

- TiN (titanium) coating improves abrasion resistance.
  - The chamfered tip allows smooth insertion into hexagon socket head bolts.
  - The rubber ring can be replaced. ➔ P.118-119.
  - \* The TiN coating on the bit is not intended to prevent rust. Please take care of the bits by applying oil, etc.
- Packing unit 5

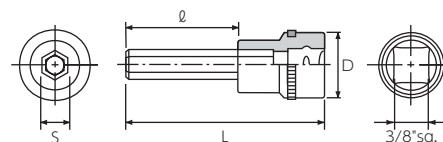

· Function mark is indicated under the product name. For the details, please refer to ➔ P.004-005.  
 · Products marked with ⚠ should be ordered after checking stock.





3/8"sq. CROSS BIT SOCKET



No.	Nominal	D	L	ℓ	Weight(g)
NBT3P-2	No.2	17	51	26	30
NBT3P-3	No.3	17	55	28	40

- TiN (titanium) coating improves abrasion resistance.
  - The rubber ring can be replaced. P.118-119.
  - \* The TiN coating on the bit is not intended to prevent rust. Please take care of the bits by applying oil, etc.
- Packing unit 5

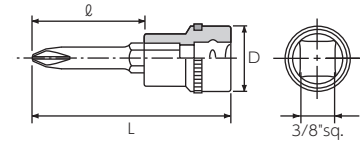

3/8"sq. T-TYPE TORX BIT SOCKET SET [5pcs.]



No.	Weight(g)
NTQ6T05A	300

Set contents	
T-type Torx Bit Socket	NQ6T25,T30,T40,T45,T50
Socket holder for 6 sockets	NEHB306

- Bit socket set in a nepros 3/8"sq. socket holder.
  - TiN (titanium) coating improves abrasion resistance.
  - The rubber ring can be replaced. P.118-119.
  - \* The TiN coating on the bit is not intended to prevent rust. Please take care of the bits by applying oil, etc.
- Packing unit 1

3/8"sq. T-TYPE TORX BIT SOCKET



No.	size	A	D	L	ℓ	Weight(g)
NQ6T25	T25	4.43	17	48	23	25
NQ6T30	T30	5.52	17	51	26	30
NQ6T40	T40	6.65	17	55	28	40
NQ6T45	T45	7.82	17	55	28	40
NQ6T50	T50	8.84	17	55	28	40

- TiN (titanium) coating improves abrasion resistance.
  - The rubber ring can be replaced. P.118-119.
  - \* The TiN coating on the bit is not intended to prevent rust. Please take care of the bits by applying oil, etc.
- Packing unit 5

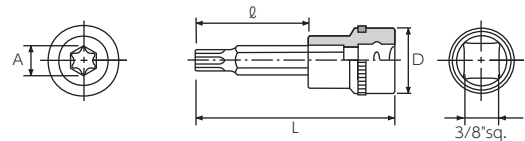

3/8"sq. E-TYPE TORX SOCKET SET [6pcs.]



No.	Weight(g)
NTQ6E06A	300

Set contents	
E-type Torx Wrench	NQ6E6,E8,E10,E12,E14,E16
Socket holder for 6 sockets	NEHB306

- E-type Torx wrench set in a nepros 3/8"sq. socket holder.
  - The rubber ring can be replaced. P.118-119.
- Packing unit 1

· Do not use hand tools with an impact wrench.

### 3/8"sq. E-TYPE TORX SOCKET



No.	size	A	D1	D2	L	Weight(g)
NQ6E6	E6	5.74	7.8	17	22.5	17
NQ6E7	E7	6.22	8.3	17	22.5	17
NQ6E8	E8	7.52	9.6	17	22.5	18
NQ6E10	E10	9.42	11.5	17	24	20
NQ6E12	E12	11.17	14.1	17	25	23
NQ6E14	E14	12.90	15.6	17	26.5	26
NQ6E16	E16	14.76	17.9	17	27.5	31

· The rubber ring can be replaced. ➔ P.118-119.  
Packing unit 5

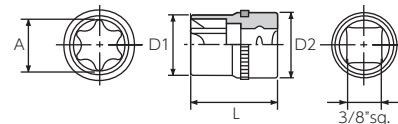

### 3/8"sq. RATCHET HANDLE



No.	Feed angle	B	φ	T	L	Weight(g)
NBR390A	4°	26	20	14	180	245

· The head has been downsized, lightened, and optimized for balance, making the ratchet handle even easier to use.  
· The use of an 8-stage claw provides the same strength as conventional products despite its small size.

\* Repair kit (NBR390A-K) is available. ➔ P.108  
\* Repair parts are set. ➔ Refer to "Repairable List" from P.625.  
Packing unit 1

**CAUTION** · To avoid damage or idling, be sure to operate the left and right switching levers securely.

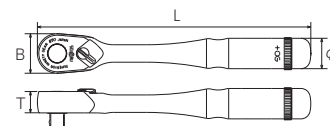

### 3/8"sq. RATCHET HANDLE (LONG)



No.	Feed angle	B	φ	T	L	Weight(g)
NBR390AL	4°	26	20	14	275	380

· The head width has been shortened to 4 mm from 30 mm to improve efficiency and ease of use in working in narrow spaces. At the same time, weight reduction has been achieved.  
· The use of an 8-stage claw provides the same strength as the conventional product (NBR390L) in spite of its small size.

· The rubber ring can be replaced. ➔ P.118-119.  
\* Repair kit (NBR390A-K) is available. ➔ P.108  
\* Repair parts are set. ➔ Refer to "Repairable List" from P.625.  
Packing unit 1

**CAUTION** · To avoid damage or idling, be sure to operate the left and right switching levers securely.  
· Be careful of overtorque due to the long overall length and the tendency to apply excessive load.

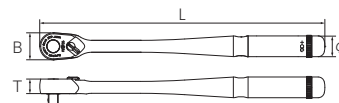

### 3/8"sq. RATCHET HANDLE (SHORT)



No.	Feed angle	B	φ	T	L	Weight(g)
NBR390AS	4°	26	17	14	100	160

· The head width has been shortened to 4mm from 30mm to improve efficiency and ease of use in working in narrow spaces. At the same time, weight reduction has been achieved.  
· The use of an 8-stage claw provides the same strength as the conventional product (NBR390S) in spite of its small size.

· The rubber ring can be replaced. ➔ P.118-119.  
\* Repair kit (NBR390A-K) is available. ➔ P.108  
\* Repair parts are set. ➔ Refer to "Repairable List" from P.625.  
Packing unit 1

**CAUTION** · To avoid damage or idling, be sure to operate the left and right switching levers securely.

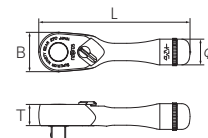

· Function mark is indicated under the product name. For the details, please refer to ➔ P.004-005.  
· Products marked with should be ordered after checking stock.



3/8"sq. RATCHET HANDLE (FLEX HEAD)

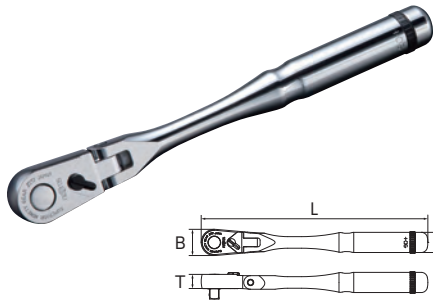

No.	Feed angle	B	φ	T	L	Weight(g)
NBR390AF	4°	26	20	14	225	320

- The head width of the conventional product (NBR390F) has been increased by 4 mm from 30 mm to improve efficiency and ease of use in working in narrow spaces. At the same time, weight reduction has been achieved.
- The use of an 8-stage claw provides the same strength as the conventional product (NBR390F) in spite of its small size.
- The rubber ring can be replaced. P.118-119.
- \* Repair kit (NBR390A-K) is available. P.108
- \* Repair parts are set. Refer to "Repairable List" from P.625.

**Flex mechanism**  
nePROS

Durable resinous holding section for smooth feeling (Flexible pivoting angle)

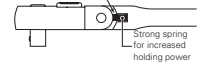

- To avoid damage or idling, be sure to operate the left and right switching levers securely.
- The flex section may become unstable if too much force is applied to it.

3/8"sq. RATCHET HANDLE (FLEX HEAD LONG)

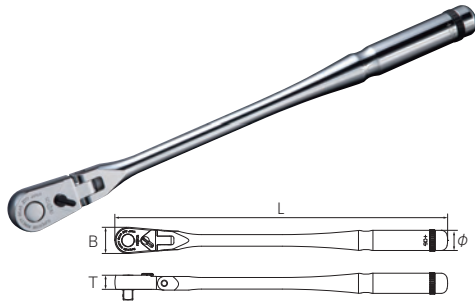

No.	Feed angle	B	φ	T	L	Weight(g)
NBR390AFL	4°	26	20	14	330	425

- The head width of the conventional product (NBR390FL) has been increased by 4 mm from 30 mm to improve efficiency and ease of use in working in narrow spaces. At the same time, weight reduction has been achieved.
- The use of an 8-stage claw provides the same strength as the conventional product (NBR390FL) in spite of its small size.
- The rubber ring can be replaced. P.118-119.
- \* Repair kit (NBR390A-K) is available. P.108
- \* Repair parts are set. Refer to "Repairable List" from P.625.



- To avoid damage or idling, be sure to operate the left and right switching levers securely.
- The flex section may become unstable if too much force is applied to it.
- Be careful of overtorque due to the long overall length and the tendency to apply excessive load.

3/8"sq. RATCHET HANDLE (STUBBY)

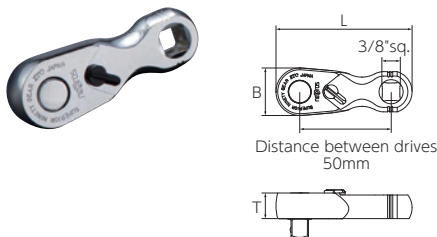

No.	Feed angle	B	T	L	Weight(g)
NBR390AH	4°	26	14	74.5	135

- The head width of the conventional product (NBR390H) was increased by 4mm from 30mm to improve efficiency and ease of use in working in narrow spaces. At the same time, weight reduction has been achieved.
- The use of an 8-stage claw provides the same strength as the conventional product (NBR390H) in spite of its small size.
- The compact design fits in the palm of the hand, making it easy to grip and comfortable in the hand.
- Can be used with 3/8"sq. insert angle in combination with a breaker bar, etc.
- \* Repair kit (NBR390A-K) is available. P.108
- \* Repair parts are set. Refer to "Repairable List" from P.625.



- To avoid damage or idling, be sure to operate the left and right switching levers securely.
- When using a combination with a breaker bar, etc., be careful of overtorque because the overall length is longer and load can be applied more easily.

REPAIR KIT FOR 3/8"sq. 90-TOOTH RATCHET HANDLE



No.	Drive size	Contents
NBR390-K	3/8"sq.	1 each of drive gear, claw, steel ball, pin, changer, changer spring, lever, lever screw, lid, and small screw×2

- Applications: NBR390, NBR390L, NBR390S, NBR390F, NBR390FL, NBR390FS, NBR390H
- \* Not applicable to NBR3UN, NBR3K, NBR3LUN, NBR3SUN, NBR3FUN (discontinued product).
- \* A 2 mm hexagonal wrench is required to remove and install the lever.
- \* Cross screwdriver (No.1) is required when replacing the head.

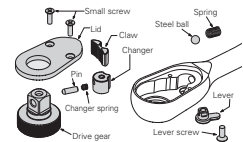

REPAIR KIT FOR 3/8"sq. 90-TOOTH RATCHET HANDLE



No.	Drive size	Contents	Weight(g)
NBR390A-K	3/8"sq.	Drive Gear Claw Pin×2 Spring×2, Lever, Lid Small screw×2	40

- Applicability: NBR390A, NBR390AL, NBR390AS, NBR390AF, NBR390AFL, NBR390AH
- \* Not applicable to NBR390, NBR390L, NBR390S, NBR390F, NBR390FL, NBR390FS, NBR390H (discontinued product).
- \* Cross screwdriver (No.1) is required when replacing the head.

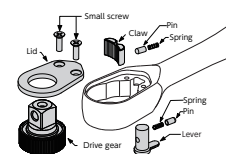

Do not use hand tools with an impact wrench.

### 3/8"sq. RATCHET HANDLE (COMPACT HEAD)

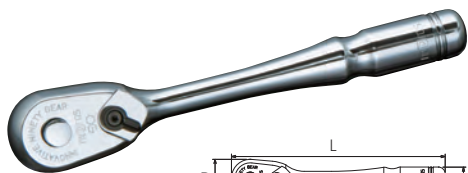

No.	Feed angle	B	φ	T	L	Weight(g)
NBRC390	4°	22	13	11	125	120

- Compact type ratchet handle with 3/8"sq. drive built into the 1/4"sq. ratchet handle body.
- The precision drive mechanism with 90 gears, 4° feed angle, and 7-step claw is condensed into a compact head.
- The push button is convex and easy to push.
- Repair kits (NBRC390-K, NBRC390-TK) are available. ➔ P.110
- \* Repair parts are set. ➔ Refer to "Repairable List" from P.625.

Packing unit 1



- To avoid damage or idling, be sure to operate the left and right switching levers securely.

### 3/8"sq. RATCHET HANDLE (COMPACT HEAD LONG)

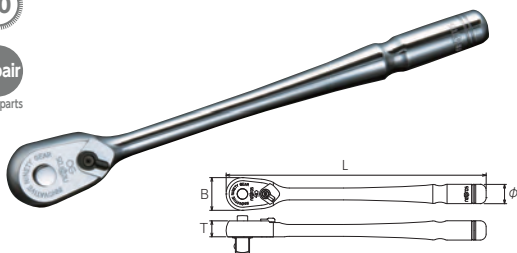

No.	Feed angle	B	φ	T	L	Weight(g)
NBRC390L	4°	22	13	11	175	150

- Compact type ratchet handle with 3/8"sq. drive built into the 1/4"sq. ratchet handle body.
- The precision drive mechanism with 90 gears, 4° feed angle, and 7-step claw is condensed into a compact head.
- The push button is convex and easy to push.
- Repair kits (NBRC390-K, NBRC390-TK) are available. ➔ P.110
- \* Repair parts are set. ➔ Refer to "Repairable List" from P.625.

Packing unit 1



- To avoid damage or idling, be sure to operate the left and right switching levers securely.
- Be careful of overtorque due to the long overall length and the tendency to apply excessive load.

### 3/8"sq. RATCHET HANDLE (COMPACT HEAD SHORT)

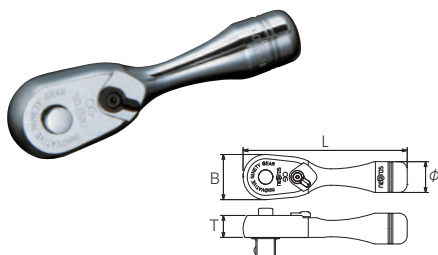

No.	Feed angle	B	φ	T	L	Weight(g)
NBRC390S	4°	22	15	11	80	90

- Compact type ratchet handle with 3/8"sq. drive built into the 1/4"sq. ratchet handle body.
- The precision drive mechanism with 90 gears, 4° feed angle, and 7-step claw is condensed into a compact head.
- The push button is convex and easy to push.
- Repair kits (NBRC390-K, NBRC390-TK) are available. ➔ P.110
- \* Repair parts are set. ➔ Refer to "Repairable List" from P.625.

Packing unit 1



- To avoid damage or idling, be sure to operate the left and right switching levers securely.

### 3/8"sq. RATCHET HANDLE (COMPACT FLEX HEAD)

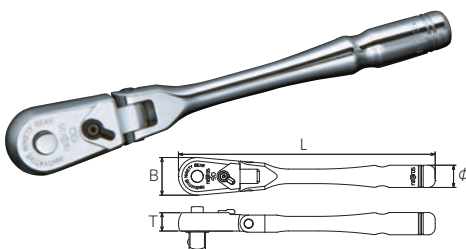

No.	Feed angle	B	φ	T	L	Weight(g)
NBRC390F	4°	22	13	11	150	140

- Compact type ratchet handle with 3/8"sq. drive built into the 1/4"sq. ratchet handle body.
- The precision drive mechanism with 90 gears, 4° feed angle, and 7-step claw is condensed into a compact head.
- The push button is convex and easy to push.
- Repair kits (NBRC390-K, NBRC390-TK) are available. ➔ P.110
- \* Repair parts are set. ➔ Refer to "Repairable List" from P.625.

Packing unit 1



- To avoid damage or idling, be sure to operate the left and right switching levers securely.
- The flex section may become unstable if too much force is applied to it.

### 3/8"sq. RATCHET HANDLE (COMPACT FLEX HEAD SHORT)

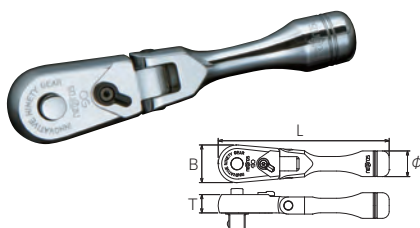

No.	Feed angle	B	φ	T	L	Weight(g)
NBRC390FS	4°	22	15	11	100	110

- Compact type ratchet handle with 3/8"sq. drive built into the 1/4"sq. ratchet handle body.
- The precision drive mechanism with 90 gears, 4° feed angle, and 7-step claw is condensed into a compact head.
- The push button is convex and easy to push.
- Repair kits (NBRC390-K, NBRC390-TK) are available. ➔ P.110
- \* Repair parts are set. ➔ Refer to "Repairable List" from P.625.

Packing unit 1



- To avoid damage or idling, be sure to operate the left and right switching levers securely.
- The flex section may become unstable if too much force is applied to it.

• Function mark is indicated under the product name. For the details, please refer to ➔ P.004-005.  
 • Products marked with ⚙️ should be ordered after checking stock.



REPAIR KIT FOR 3/8"sq. 90-TOOTH COMPACT RATCHET HANDLE

3/8" sq.

90



No.	Drive size	Contents	Weight(g)
NBRC390-K	3/8"sq.	1 each of drive gear, claw, steel ball, pin, changer, changer spring, spring, lever, lever screw, lid, and small screw × 2	32

- Applicable: NBRC390, NBRC390L, NBRC390S, NBRC390F, NBRC390FS
- \* Not applicable to NBRC3UN, NBRC3SUN, NBRC3FUN, and NBR3FSCUN.
- \* A T-shaped Torx wrench (T6) is required to remove and install the lever of the NBRC390 series. If you do not have one, please purchase NBRC390-TK.
- ➔ P.110
- \* Cross screwdriver (No.1) is required when replacing the head.

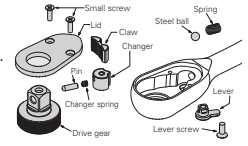

REPAIR KIT FOR 3/8"sq. 90-TOOTH COMPACT RATCHET HANDLE

3/8" sq.

90



No.	Drive size	Contents	Weight(g)
NBRC390-TK	3/8"sq.	NBRC390-K Contents + T-type Torx L-Handle Wrench LT6	35

- Applicable: NBRC390, NBRC390L, NBRC390S, NBRC390F, NBRC390FS
- \* NBRC3UN, NBRC3SUN, NBRC3FUN, and NBR3FSCUN are not applicable.
- \* Cross screwdriver (No.1) is required when replacing the head.

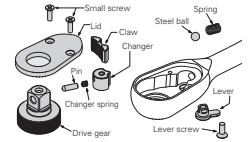

3/8"sq. RATCHET ADAPTER

3/8" sq.

72

POWERFIT

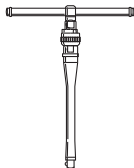

Transforms into a T-shaped ratchet when combined with a drive tool

No.	Feed angle	D1	D2	L	Weight(g)
NBRA3	5°	29	17.7	49	130

- The number of gear teeth is 72, and the feed angle is as fine as 5°, which improves workability.
- When combined with the slide head handle and extension bar, it can be used as a T-shaped ratchet.
- The rubber ring can be replaced. ➔ P.118-119.

CAUTION To avoid damage or idling, be sure to operate the left and right switching levers securely.

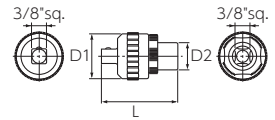

3/8"sq. BREAKER BAR

3/8" sq.

Repair Spare parts

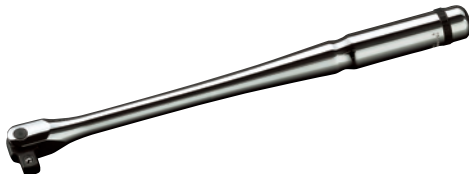

No.	B	b	φ	L	Weight(g)
NBS3	18	29.5	22	300	460

- The rubber ring can be replaced. ➔ P.118-119.
- \* Repair kit (NBS3-K) is set. ➔ P.111
- \* Repair parts are set. ➔ Refer to "Repairable List" from P.625.

CAUTION Hold the center of the grip as the drive may pinch your hand. Be careful of overtorque due to the long overall length and the tendency to apply excessive load.

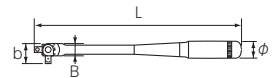

3/8"sq. BREAKER BAR (LONG)

3/8" sq.

Repair Spare parts



No.	B	b	φ	L	Weight(g)
NBS3L	18	29.5	22	400	520

- The rubber ring can be replaced. ➔ P.118-119.
- \* Repair kit (NBS3-K) is set. ➔ P.111
- \* Repair parts are set. ➔ Refer to "Repairable List" from P.625.

CAUTION Hold the center of the grip as the drive may pinch your hand. Be careful of overtorque due to the long overall length and the tendency to apply excessive load.

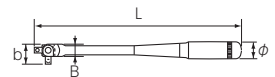

• Do not use hand tools with an impact wrench.



REPAIR KIT FOR 3/8"sq. BREAKER BAR HEAD

3/8" sq.



No.	Drive size	Contents	Weight(g)
NBS3-K	3/8"sq.	1 each of drive head, pin, set screw, 2 each of plastic pad and spring	35

\* Two types of pads and springs, old and new, are included with the NBS3-K, but only one of each is used. (Please refer to the instruction manual for details.)

\* A 1.5mm hexagonal wrench is required when replacing the head.

Part number NBS3, NBS3K, NBS3L

· This repair kit applies to products with the above part numbers:

· However, in the case of NBS3 and NBS3L, this is limited to products with "A" or "B" stamped on the body.

· Do not use this repair kit for products that do not have "A" or "B" marked on the handle.

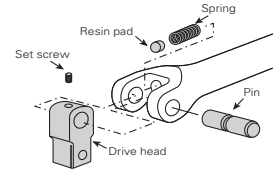
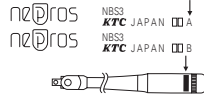

3/8"sq. SLIDE HEAD HANDLE

3/8" sq.

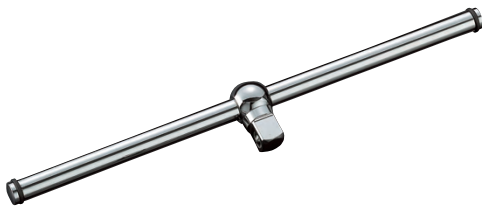

No.	D	d	H	L	Weight(g)
NBHM3	13	9	26	200	115

· The head is spherical and more compact.

· The head moves to the end of the handle so that the tip is less likely to bother.

It also has a stop position in the center for improved workability.

Packing unit 5

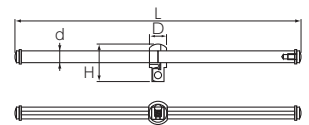

3/8"sq. T-SHAPED HANDLE

3/8" sq.



No.	d	L	ℓ	Weight(g)
NBHT3	10.3	256	200	360

· Weights are placed at both ends of the handle to improve balance when turning quickly and to enhance workability.

\* Repair parts are set.

Packing unit 5

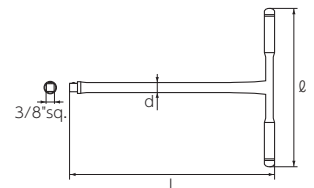

3/8"sq. GRIP TYPE HANDLE

3/8" sq.

POWERFIT



No.	D	L	Weight(g)
NBE38	35	26	65
NBEC38	27.4	25	40

· This is a special driving tool for fast turning that is more effective when used in combination with a ratchet handle or extension bar. (under light load).

· The rubber ring can be replaced. ➔ P.118-119.

Packing unit 5

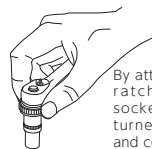

By attaching it between the ratchet handle and the socket, the socket can be turned quickly for speedy and comfortable work. It can be used for both tightening and loosening work.

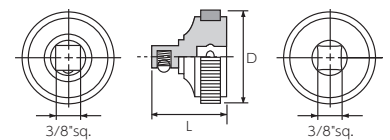

3/8"sq. EXTENSION BAR SET [3pcs.]

3/8" sq.

3 pcs.

POWERFIT

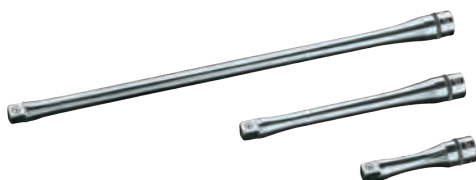

No.	Weight(g)
NTBE303	500

Set contents

Extension bar NBE3-075,150,300

· The rubber ring can be replaced. ➔ P.118-119.

Packing unit 1



· Do not use more than two connected wires.

· Function mark is indicated under the product name. For the details, please refer to ➔ P.004-005.  
· Products marked with ⚠ should be ordered after checking stock.



3/8"sq. EXTENSION BAR SET [6pcs.]



No.	Weight(g)
NTBE306	655
Set contents	
Extension bar	NBE3-030,050,075,100,150,300

· The rubber ring can be replaced. P.118-119.  
Packing unit 1



· Do not use more than two connected wires.

3/8"sq. EXTENSION BAR



No.	D	L	Weight(g)
NBE3-030	17	30	35
NBE3-050	17	50	50
NBE3-075	17	75	80
NBE3-100	17	100	100
NBE3-150	17	150	140
NBE3-300	17	300	250

· The streamlined form reduces deflection to a minimum.  
· The rubber ring can be replaced. P.118-119.  
Packing unit 5



· Do not use more than two connected wires.

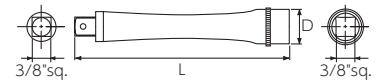

3/8"sq. WOBBLE EXTENSION BAR SET [3pcs.]

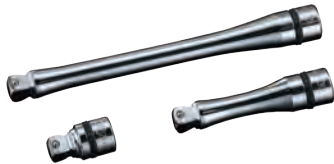

No.	Weight(g)
NTBE303JW	300
Set contents	
Wobble extension bar	NBE3-030JW,075JW,150JW

· Straight hold mechanism. The socket can be held straight by inserting it deeper than the normal mounting position (flex position).  
· The strength in the straight hold state is 30% higher than in the swivel state.  
· The rubber ring can be replaced. P.118-119.  
Packing unit 1



· Be careful not to exert excessive force, as the load capacity is lower than that of a normal extension bar due to its structure.  
· Do not use more than two connected wires.

Swing angle approx. 13°

Straight hold mechanism

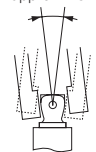
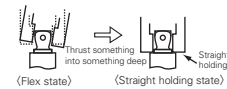

3/8"sq. WOBBLE EXTENSION BAR

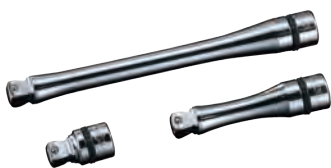

No.	D	L	Weight(g)
NBE3-030JW	17	30	35
NBE3-050JW	17	50	50
NBE3-075JW	17	75	80
NBE3-100JW	17	100	100
NBE3-150JW	17	150	140

· The rubber ring can be replaced. P.118-119.  
Packing unit 5



· Be careful not to exert excessive force, as the load capacity is lower than that of a normal extension bar due to its structure.  
· Do not use more than two connected wires.

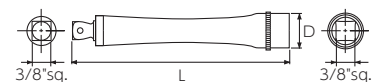

· Do not use hand tools with an impact wrench.

### 3/8"sq. UNIVERSAL JOINT

3/8" sq.

POWERFIT

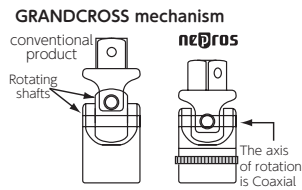

No.	D	L	Weight(g)
NBJ3	19	41	50

- The GRANDCROSS mechanism with two rotating shafts on the same axis provides smooth movement and excellent torque transmission, which nepros is proud of.
- The overall length is only 41mm, 4mm shorter than the conventional product.
- The high-strength design with suppressed mouth opening and high-grade spring washers have improved pivoting retention and durability.
- The rubber ring can be replaced. P.118-119.

Packing unit 5



• The joint part is vulnerable to impact and pry, so be careful not to exert excessive force.

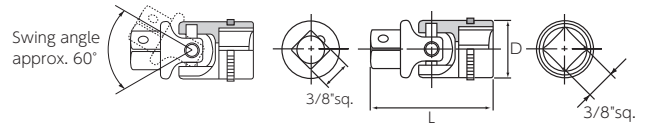

### 3/8"sq. SOCKET ADAPTER

3/8" sq.

1/4" sq.

3/8" sq.

1/2" sq.

POWERFIT



NBA32



NBA34

No.	sq.		D	L	Weight(g)
	Concave	Convex			
NBA32	3/8"	1/4"	17	25.5	20
NBA34	3/8"	1/2"	17	29.5	35

• The rubber ring can be replaced. P.118-119.

Packing unit 5



• The limiting torque of the adapter is based on the smaller drive size. Be careful not to apply too much force.

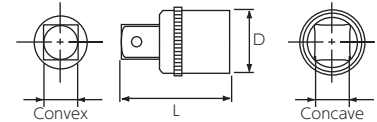

### 3/8"sq. SOCKET HOLDER

3/8" sq.

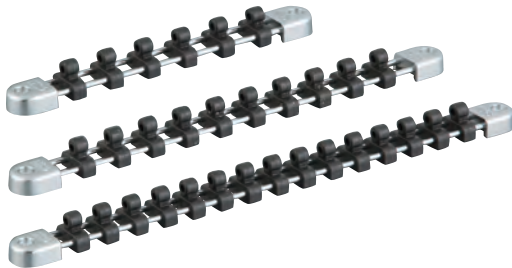

No.	Number of clips	H	A	L	Weight(g)
NEHB306	6	23	25	219	120
NEHB310	10	23	25	319	160
NEHB315	15	23	25	369	180

Packing unit 5



• The socket holder may fall out if the socket holder is turned upside down.

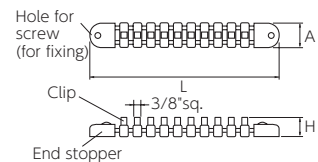

#### Spare parts

No.	Weight(g)
NTEHB305	19

#### Set contents

Spare clip set for 3/8"sq. socket holder, 5 pieces

- Spare clip for NEHB306, NEHB310, NEHB315.
- Also available for NEHB206-215(1/4"sq.), 406-410(1/2"sq.).

Packing unit 5

### 1/2"sq. SOCKET WRENCH SET [17pcs.]

1/2" sq.

17 pcs.

90

6pt.

POWERFIT



No.	Weight(kg)
NTB417A	3

#### Set contents

Sockets (6pt.)	NB4-10,12,13,14,17,19,21,22,24,27,30,32
Ratchet handle	NBR490
Breaker bar	NBS4
Extension bar	NBE4-075,150
Universal joint	NBJ4
Tray (W447×D185×H30)	NTB417A-TR

- This is a model of NTB417AZ without a case.
- The tray is set to fit into the NEKB-2 metal case (P.097).
- The rubber ring can be replaced. P.118-119.

Packing unit 1

• Function mark is indicated under the product name. For the details, please refer to P.004-005.  
 • Products marked with should be ordered after checking stock.



**1/2"sq. SOCKET WRENCH SET [17pcs.]**

1/2" sq.

17 pcs.

90

6pt.

POWERFIT



No.	Weight(kg)	
NTB417AZ	4.6	
Set contents		
Sockets (6pt.)	NB4-10,12,13,14,17,19,21,22,24,27,30,32	
Ratchet handle	NBR490	
Breaker bar	NBS4	
Extension bar	NBE4-075,150	
Universal joint	NBJ4	
Metal case (W455×D190×H60)	NEKB-2	
Tray (W447×D185×H30)	NTB417A-TR	

· This model is NTB417A with case. The case is shown on P.097.  
 · The rubber ring can be replaced. P.118-119.  
 Packing unit 1

**1/2"sq. SOCKET SET [6pcs.]**

1/2" sq.

6 pcs.

6pt.

POWERFIT



No.	Weight(g)	
NTB406A	500	
Set contents		
Sockets (6pt.)	NB4-10,12,13,14,17,19	
Socket holder for 6 sockets	NEHB406	

· Socket set in a nepros 1/2"sq. socket holder.  
 · The rubber ring can be replaced. P.118-119.  
 Packing unit 1

**1/2"sq. SOCKET SET [12pcs.]**

1/2" sq.

12 pcs.

6pt.

POWERFIT



No.	Weight(kg)	
NTB412A	1.4	
Set contents		
Sockets (6pt.)	NB4-10,12,13,14,17,19,21,22,24,27,30,32	
Socket holder for 6 or 10 sockets	NEHB406,410	

· Socket set in a nepros 1/2"sq. socket holder.  
 · The rubber ring can be replaced. P.118-119.  
 Packing unit 1

**1/2"sq. SOCKET**

1/2" sq.

6pt.

POWERFIT

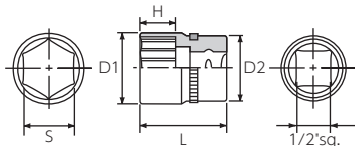

No.	S	D1	D2	H	L	Weight(g)
NB4-10	10	14.4	21	5.5	28.5	33
NB4-11	11	15.7	21	6	29	36
NB4-12	12	17	21	7.5	30.5	37
NB4-13	13	18.5	21	7.5	30.5	40
NB4-14	14	19.5	21	8.5	31.5	42
NB4-15	15	20.7	21	8.5	31.5	44
NB4-16	16	22.1	21	9	33	49
NB4-17	17	23.3	21.5	10	34	54
NB4-18	18	24.7	23	10	34	65
NB4-19	19	25.6	24	10.5	34.5	71
NB4-20	20	26.6	25	11	35	79
NB4-21	21	28.1	25	11.5	35.5	83
NB4-22	22	29.1	26	11.5	35.5	90
NB4-24	24	31.6	27	12	36	102
NB4-27	27	35.1	29	15	39	130
NB4-30	30	38.6	31	17	42	163
NB4-32	32	41.2	32.5	18	43	187

· The rubber ring can be replaced. P.118-119.  
 Packing unit 5

· Do not use hand tools with an impact wrench.

### 1/2"sq. DEEP SOCKET SET [6pcs.]



No.	Weight(g)	
NTB4L06A	700	
Set contents		
Deep sockets (6pt.)	NB4L-10,12,13,14,17,19	
Socket holder for 6 sockets	NEHB406	
<ul style="list-style-type: none"> <li>Socket set in a nepros 1/2"sq. socket holder.</li> <li>The rubber ring can be replaced.  P.118-119.</li> </ul>		
Packing unit 1		

### 1/2"sq. DEEP SOCKET



No.	S	D1	D2	H	L	Weight(g)
NB4L-10	10	14.4	21	11	80	75
NB4L-11	11	15.7	21	12	80	84
NB4L-12	12	17	21	14	80	89
NB4L-13	13	18.5	21	14	80	100
NB4L-14	14	19.5	21	17	80	110
NB4L-15	15	20.7	21	17	80	118
NB4L-16	16	22.1	21	17	85	138
NB4L-17	17	23.3	21.5	17	85	149
NB4L-18	18	24.7	23	21	85	169
NB4L-19	19	25.6	24	21	85	177
NB4L-21	21	28.1	25	23	85	203
NB4L-22	22	29.1	26	23	85	214
NB4L-24	24	31.6	27	27	85	240

The rubber ring can be replaced. P.118-119.  
Packing unit 5

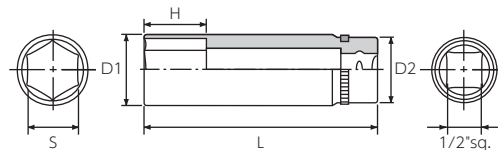

### 1/2"sq. RATCHET HANDLE



Spare parts



Repairable

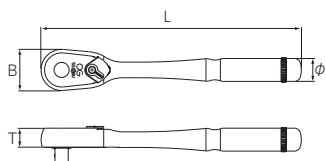

No.	Feed angle	B	φ	T	L	Weight(g)
NBR490	4°	39.5	22	19	250	610

The world's highest class 90 gears are used for the small size type to achieve unprecedented smooth movement and strength.  
The rubber ring can be replaced. P.118-119.  
\* Repair kit (NBR490-K) is available. P.116  
\* Repair parts are set. Refer to "Repairable List" from P.625.  
Packing unit 1



To avoid damage or idling, be sure to operate the left and right switching levers securely.

### 1/2"sq. RATCHET HANDLE (LONG)



Spare parts



Repairable

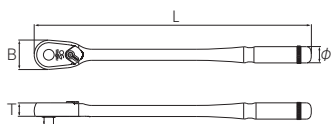

No.	Feed angle	B	φ	T	L	Weight(g)
NBR490L	4°	39.5	22	19	375	790

The world's highest class 90 gears are used for the small size type to achieve unprecedented smooth movement and strength.  
The rubber ring can be replaced. P.118-119.  
\* Repair kit (NBR490-K) is available. P.116  
\* Repair parts are set. Refer to "Repairable List" from P.625.  
Packing unit 1



To avoid damage or idling, be sure to operate the left and right switching levers securely.  
Be careful of overtorque due to the long overall length and the tendency to apply excessive load.

Function mark is indicated under the product name. For the details, please refer to P.004-005.  
Products marked with should be ordered after checking stock.





REPAIR KIT FOR  
1/2"sq. 90-TOOTH RATCHET HANDLE

1/2" sq.

90

PUSH



No.	Drive size	Contents	Weight(g)
NBR490-K	1/2"sq.	1 each of drive gear, claw, steel ball, pin, changer, changer spring, spring, lever, lever screw, lid, and small screw x2	150

- Application: NBR490, NBR490L
- \* Not applicable to NBR4UN and NBR4LUN (discontinued product).
- \* A 2 mm hexagonal wrench is required to remove and install the lever.
- \* Cross screwdriver (No.2) is required when replacing the head.

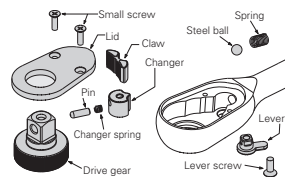

nepros SOCKETS AND DRIVE TOOLS

1/2"sq. BREAKER BAR

1/2" sq.

Repair

Spare parts

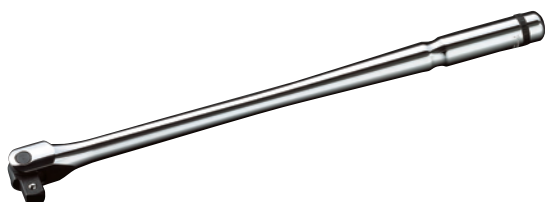

No.	B	b	φ	L	Weight(g)
NBS4	22	38	22	400	700

- The rubber ring can be replaced. P.118-119.
  - \* Repair kit (NBS4-K) is set. P.116
  - \* Repair parts are set. Refer to "Repairable List" from P.625.
- Packing unit 5



- Hold the center of the grip as the drive may pinch your hand.
- Be careful of overtorque due to the long overall length and the tendency to apply excessive load.

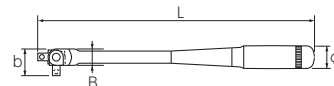

REPAIR KIT FOR 1/2"sq. BREAKER BAR HEAD

1/2" sq.



No.	Drive size	Contents	Weight(g)
NBS4-K	1/2"sq.	Drive head, pin, set screw, plastic pad, spring 1 each	70

- \* A 2.5mm hexagonal wrench is required when replacing the head.
- Part number NBS4
- This repair kit applies to products with the above part numbers.
  - However, only products with an "A" stamped on the breaker bar handle to the right of the above part number will be accepted.
  - Please note that this does not apply to products not marked with "A".

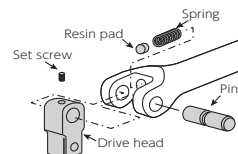

1/2"sq. GRIP TYPE HANDLE

1/2" sq.

POWERFIT



No.	D	L	Weight(g)
NBE48	40	35	80

- This is a special driving tool for fast turning that is more effective when used in combination with a ratchet handle or extension bar. (under light load).
  - The rubber ring can be replaced. P.118-119.
- Packing unit 5

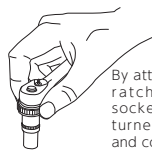

By attaching it between the ratchet handle and the socket, the socket can be turned quickly for speedy and comfortable work. It can be used for both tightening and loosening work.

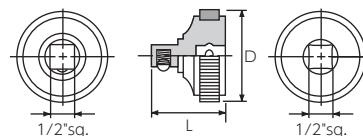

1/2"sq. EXTENSION BAR SET [3pcs.]

1/2" sq.

3 pcs.

POWERFIT



No.	Weight(g)
NTBE403	800

Set contents	
Extension bar	NBE4-075,150,300

- The rubber ring can be replaced. P.118-119.
- Packing unit 1



- Do not use more than two connected wires.

• Do not use hand tools with an impact wrench.

### 1/2"sq. EXTENSION BAR

1/2" sq.

POWERFIT



No.	D	L	Weight(g)
NBE4-075	22	75	120
NBE4-150	22	150	230
NBE4-300	22	300	420

- The streamlined form reduces deflection to a minimum.
- The rubber ring can be replaced. ➔ P.118-119.

Packing unit 5



- Do not use more than two connected wires.

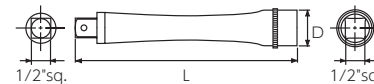

### 1/2"sq. SOCKET ADAPTER

1/2" sq.

3/8" sq.

POWERFIT



No.	sq.		D	L	Weight(g)
	Concave	Convex			
NBA43	1/2"	3/8"	20.5	35	40

- The rubber ring can be replaced. ➔ P.118-119.

Packing unit 5



- The limiting torque of the adapter is based on the smaller drive size. Be careful not to apply too much force.

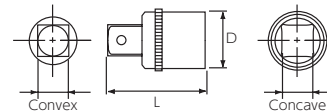

### 1/2"sq. UNIVERSAL JOINT

1/2" sq.

POWERFIT



No.	D	L	Weight(g)
NBJ4	24.8	57	125

- The GRANDCROSS mechanism with two rotating shafts on the same axis provides smooth movement and excellent torque transmission, which nepros is proud of.
- The high-strength design with suppressed mouth opening and high-grade spring washers have improved pivoting retention and durability.
- The rubber ring can be replaced. ➔ P.118-119.

Packing unit 5



- The joint part is vulnerable to impact and pry, so be careful not to exert excessive force.

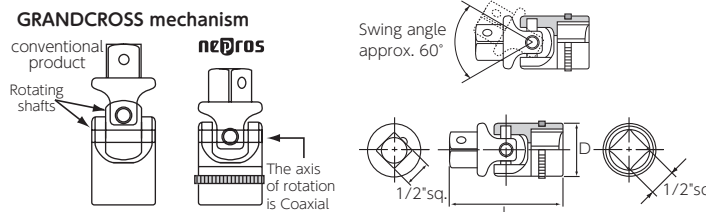

### 1/2"sq. SOCKET HOLDER

1/2" sq.

Repair Spare parts

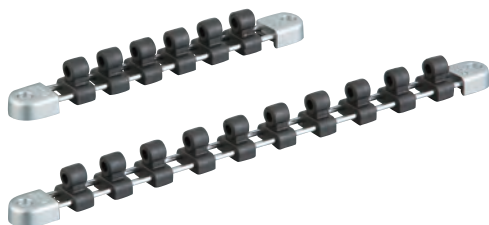

No.	Number of clips	H	A	L	Weight(g)
NEHB406	6	26.5	25	219	160
NEHB410	10	26.5	25	369	190

Packing unit 5



- The socket holder may fall out if the socket holder is turned upside down.

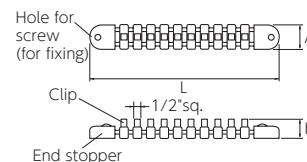

#### Spare parts

No.	Weight(g)
NTEHB405	28

Set contents

Spare clip set for 1/2"sq. socket holder 5 pcs.

- Spare clip for NEHB406 and NEHB410.
- Also available for NEHB206-215(1/4"sq.), 306-315(3/8"sq.).

Packing unit 5

· Function mark is indicated under the product name. For the details, please refer to ➔ P.004-005.  
 · Products marked with ⚠ should be ordered after checking stock.



RUBBER RING SET



Example of use (black)



Example of use (red)



Example of use (blue)



Example of use (yellow)

No.1 Rubber ring set

No.	Variety	Contents
NTYR0110	Black	No.1 rubber ring×10 pcs.
NTYR0110R	Red	
NTYR0110B	Green	
NTYR0110Y	Yellow	

Applicable part number

NB3-055~15, NB3-08W~15W, NB3-1/4~19/32, NB3M-055~15, NB3M-1/4~9/16, NB3M-1/4W~9/16W, NB3L-055~15, NB3L-08W~14W, NB3L-1/4~9/16, NB3L-1/4W~9/16W, NB3-13SP, NB3-14SP, NBT3-04~08, NBT3P-2~3, NBE3-030~300, NBE3-030JW~150JW, NQ6E6~16, NQ6T25~50, NBR3SUN, NBR3FSCUN, NBR390S, NBR390AS, NBR390FS

\* NBR3FSCUN may not have applicable rubber rings due to design changes.

No.2 Rubber ring set

No.	Variety	Contents
NTYR0210	Black	No.2 rubber ring×10 pcs.
NTYR0210R	Red	
NTYR0210B	Green	
NTYR0210Y	Yellow	

Applicable part number

NB3-16~18, NB3-16W~18W, NB3-5/8~11/16, NB3M-16~18, NB3M-5/8~11/16, NB3M-5/8W~11/16W, NB3L-16~18, NB3L-5/8~11/16, NB3L-5/8W~11/16W, NB3L-17W, NB3-16SP, NB3-08JU~14JU, NBA32, NBA34, NB3J3

No.3 Rubber ring set

No.	Variety	Contents
NTYR0305	Black	No.3 rubber ring×5 pcs.
NTYR0305R	Red	
NTYR0305B	Green	
NTYR0305Y	Yellow	

Applicable part number

NB3-19~20, NB3-19W, NB3-3/4, NB3M-19, NB3L-19, NB3L-19W, NB3L-3/4, NB3L-3/4W, NB3-18SP, NBA43

No.4 Rubber ring set

No.	Variety	Contents
NTYR0405	Black	No.4 rubber ring×5 pcs.
NTYR0405R	Red	
NTYR0405B	Green	
NTYR0405Y	Yellow	

Applicable part number

NB3-21~22, NB3-21W~22W, NB3-13/16~7/8, NB3L-21~22, NB3L-21W~22W, NB3L-13/16~7/8, NB3L-13/16W~7/8W, NB3-208SP

No.5 Rubber ring set

No.	Variety	Contents
NTYR0503	Black	No.5 rubber ring×3 pcs.
NTYR0503R	Red	
NTYR0503B	Green	
NTYR0503Y	Yellow	

Applicable part number

NB3-23~24, NB3-24W, NB3-15/16~1, NB3L-24, NB3L-24W, NB3L-15/16, NB3L-15/16W

No.6 Rubber ring set

No.	Variety	Contents
NTYR0602	Black	No.6 rubber ring×2 pcs.
NTYR0602R	Red	
NTYR0602B	Green	
NTYR0602Y	Yellow	

Applicable part number

NBR3UN, NBR3FUN, NBR3LUN, NBR390, NBR390A, NBR390L, NBR390AL, NBR390F, NBR390AF, NBR390FL, NBR390AFL, NBRM3, NBR4UN, NBR4LUN, NBR490, NBR490L, NBS3, NBS3L, NBS4

\* No.2 rubber ring is applicable to early type NBR3UN, NBR3FUN, and NBR3LUN (rubber ring width: 3mm).

No.7 Rubber ring

No.	Variety	Contents
NTYR0701	Black	No.7 rubber ring×1 piece
NTYR0701R	Red	
NTYR0701B	Green	
NTYR0701Y	Yellow	

Applicable part number

NBE38

No.8 Rubber ring set

No.	Variety	Contents
NTYR0810	Black	No.8 rubber ring×10 pcs.
NTYR0810R	Red	
NTYR0810B	Green	
NTYR0810Y	Yellow	

Applicable part number

NB4-10~21, NB4L-10~21, NBE4-075~300, NB3J4

No.9 Rubber ring set

No.	Variety	Contents
NTYR0903	Black	No.9 rubber ring×3 pcs.
NTYR0903R	Red	
NTYR0903B	Green	
NTYR0903Y	Yellow	

Applicable part number

NB4-22~24, NB4L-22~24

No.10 Rubber ring set

No.	Variety	Contents
NTYR1003	Black	No.10 rubber ring×3 pcs.
NTYR1003R	Red	
NTYR1003B	Green	
NTYR1003Y	Yellow	

Applicable part number

NB4-27~32

• Do not use hand tools with an impact wrench.

No.11 Rubber ring				
No.	Variety	Contents		
NTYR1101	NTYR1101	Black	No.11 rubber ring×1 piece	
	NTYR1101R	Red		
	NTYR1101B	Green		
	NTYR1101Y	Yellow		
Applicable part number				
NBE48				

No.12 Rubber ring				
No.	Variety	Contents		
NTYR1201	NTYR1201	Black	No.12 rubber ring×1 piece	
	NTYR1201R	Red		
	NTYR1201B	Green		
	NTYR1201Y	Yellow		
Applicable part number				
NBAE23, NBE28, NBEC38				

No.13 Rubber ring				
No.	Variety	Contents		
NTYR1301	NTYR1301	Black	No.13 rubber ring×1	
	NTYR1301R	Red		
	NTYR1301B	Green		
	NTYR1301Y	Yellow		
Applicable part number				
NBRA3				

Rubber ring set for 3/8"sq. socket wrench set				
No.	Variety	Contents		
NTYR34X	NTYR34X	Black	No.1×21 pieces, No.2×3 pieces, No.3×3 pieces, No.4×3 pieces, No.5×1 piece, No.6×2 pieces, No.7×1 piece	
	NTYR34RX	Red		
	NTYR34BX	Green		
	NTYR34YX	Yellow		

• Compatible with sockets, etc. included in tool sets such as NTX1WA70, NTX8700A, NTX8701A, NTX759A, etc.

Rubber ring set for 3/8"sq. socket set				
No.	Variety	Contents		
NTYR20X	NTYR20X	Black	No.1×11 pieces, No.2×3 pieces, No.3×2 pieces, No.4×3 pieces, No.5×1 piece	
	NTYR20RX	Red		
	NTYR20BX	Green		
	NTYR20YX	Yellow		

• Compatible with 3/8"sq. socket sets up to NTB320A, etc.

Rubber ring set for 1/2"sq. socket wrench set				
No.	Variety	Contents		
NTYR18X	NTYR18X	Black	No.6×2 pieces, No.8×11 pieces, No.9×2 pcs, No.10×3 pcs	
	NTYR18RX	Red		
	NTYR18BX	Green		
	NTYR18YX	Yellow		

• Compatible with NTB417A and other socket wrench sets.

- This is a replacement part for the rubber rings used in nepros sockets and handles.
- In addition to the standard black color, red, blue, and yellow color variations are available.
- The tool can be changed from standard black to colored rubber rings to assert individuality and to distinguish it from other people's tools.
- Separating colors by inch, millimeter, 3/8"sq. and 1/2"sq. etc. makes it easier to identify and improves work efficiency.

Application Chart by Part Number

Part number	Rubber ring No.	Part number	Rubber ring No.
NB3-055~15	1	NBA43	3
NB3-08JU~14JU	2	NBAE23	12
NB3-08W~15W	1	NBE28	12
NB3-1/4~19/32	1	NBE3-030~300	1
NB3-13/16~7/8	4	NBE3-030JW~150JW	1
NB3-13SP	1	NBE38	7
NB3-14SP	1	NBE4-075~300	8
NB3-15/16~1	5	NBE48	11
NB3-16~18	2	NBEC38	12
NB3-16SP	2	NBJ3	2
NB3-16W~18W	2	NBJ4	8
NB3-18SP	3	NBR390, NBR390A	6
NB3-19~20	3	NBR390F, NBR390AF	6
NB3-19W	3	NBR390FL, NBR390AFL	6
NB3-208SP	4	NBR390FS	1
NB3-21~22	4	NBR390L, NBR390AL	6
NB3-21W~22W	4	NBR390S, NBR390AS	1
NB3-23~24	5	NBR3FSCUN * 2	1
NB3-24W	5	NBR3FUN * 1	6
NB3-3/4	3	NBR3LUN * 1	6
NB3-5/8~11/16	2	NBR3SUN	1
NB3L-055~15	1	NBR3UN * 1	6
NB3L-08W~14W	1	NBR490	6
NB3L-16~18	2	NBR490L	6
NB3L-17W	2	NBR4LUN	6
NB3L-19	3	NBR4UN	6
NB3L-19W	3	NBRA3	13
NB3L-21~22	4	NBRM3	6
NB3L-21W~22W	4	NBS3	6
NB3L-24	5	NBS3L	6
NB3L-24W	5	NBS4	6
NB3M-055~15	1	NBT3-04~08	1
NB3M-1/4~9/16	1	NBT3P-2~3	1
NB3M-1/4W~9/16W	1	NQ6E6~16	1
NB3M-16~18	2	NQ6T25~50	1
NB3M-19	3	NB3L-1/4~9/16	1
NB3M-5/8~11/16	2	NB3L-1/4W~9/16W	1
NB3M-5/8W~11/16W	2	NB3L-5/8~11/16	2
NB4-10~21	8	NB3L-5/8W~11/16W	2
NB4-22~24	9	NB3L-3/4	3
NB4-27~32	10	NB3L-3/4W	3
NB4L-10~21	8	NB3L-13/16~7/8	4
NB4L-22~24	9	NB3L-13/16W~7/8W	4
NBA32	2	NB3L-15/16	5
NBA34	2	NB3L-15/16W	5

\* 1 No.2 rubber ring is applicable for Initial type of NBR3UN, NBR3FUN, and NBR3LUN (ring width 3mm).

\* 2 NBR3FSCUN may not have applicable rubber rings due to design changes.

• Function mark is indicated under the product name. For the details, please refer to P.004-005.  
 • Products marked with  should be ordered after checking stock.



nepros

---

WRENCHS



45°×6°BOX END WRENCH SET [6pcs.]

6 pcs.

12pt.

POWERFIT



No.	Weight(kg)
NTM506	1
Set contents	
45° × 6° box end wrench	NM5-0810,1012,1214,1417,1921,2224
* Includes plastic tray (W445×D185×H35).	
* Resin trays do not fit into NEKB-2 and EKB-2 (metal case).	
Packing unit 1	

45°×6°BOX END WRENCH

12pt.

POWERFIT

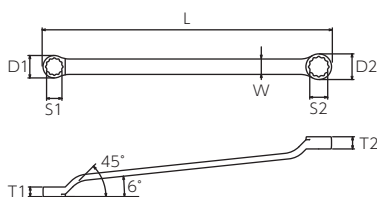

No.	S1×S2	D1	D2	T1	T2	W	L	Weight(g)
NM5-05507	5.5× 7	9	11	4.5	5	6.5	150	25
NM5-0607	6 × 7	9	11	4.5	5	6.5	150	25
NM5-0708	7 × 8	11	12	5	5.5	7.5	167	35
NM5-0809	8 × 9	12	13.5	5.5	6	8.5	172.5	40
NM5-0810	8 × 10	12	14.5	5.5	6.5	8.5	180	40
NM5-1012	10 × 12	14.5	17.5	6.5	7.5	10	205	70
NM5-1113	11 × 13	16	18.5	7	8.5	11	214	85
NM5-1214	12 × 14	17.5	20	7.5	9.5	12	225	100
NM5-1315	13 × 15	18.5	21.5	8.5	10	13	235	116
NM5-1417	14 × 17	20	24.5	9.5	11	13.5	245	140
NM5-1618	16 × 18	23	26	10.5	11.5	15	264.5	185
NM5-1719	17 × 19	24.5	27	11	12	16	284	220
NM5-1921	19 × 21	27	30	12	13	17.5	300	270
NM5-2224	22 × 24	31.5	34	13.5	15	20	335	380
NM5-2730	27 × 30	38	42.5	16.5	18	23	405	645
NM5-2832	28 × 32	40	45	17.5	18	24	427.5	753

Packing unit 5

45°×6°BOX END WRENCH SET (SHORT) [4pcs.]

4 pcs.

12pt.

POWERFIT



No.	Weight(g)
NTM5504	300
Set contents	
45° × 6° box end wrench (short)	NM5S-0810,1012,1214,1417
Packing unit 1	

45°×6°BOX END WRENCH (SHORT)

12pt.

POWERFIT



No.	S1×S2	D1	D2	T1	T2	W	L	Weight(g)
NM5S-0810	8×10	12	14.5	5.5	6.5	7.6	105	30
NM5S-1012	10×12	14.5	17.5	6.5	7.5	9	125	40
NM5S-1214	12×14	17.5	20	7.5	9.5	11	145	65
NM5S-1315	13×15	18.5	21.5	8.5	10	11.5	155	75
NM5S-1417	14×17	20	24.5	9.5	11	12	165	90

Packing unit 5

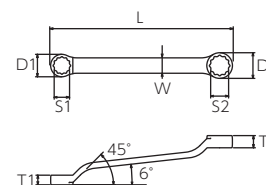

· Function mark is indicated under the product name. For the details, please refer to P.004-005.  
 · Products marked with should be ordered after checking stock.



15°BOX END WRENCH SET [6pcs.]

6 pcs.

12pt.



No.	Weight(g)
NTM206	665

Set contents	NM2- 0810,1012,1214,1315,1417,1719
--------------	------------------------------------

- Includes plastic tray (W445×D185×H35).
  - The rise angle is set at straight (0°) × 15°, between the standard type (45°) and the straight type (0°).
  - The outside diameter of the wrench protrudes on one side, so it can be used even when the bolt or nut has a seat around it.
  - The straight outer circumference of the aperture improves workability in more confined spaces.
- \* Resin trays do not fit into NEKB-2 and EKB-2 (metal case).  
Packing unit 1

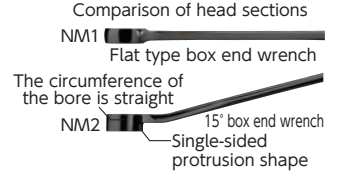

15°BOX END WRENCH

12pt.



No.	S1×S2	D1	D2	T1	T2	W	L	Weight(g)
NM2-0810	8×10	12	14.5	5.7	6.7	8.5	180	45
NM2-1012	10×12	14.5	17.5	6.7	7.7	10	205	65
NM2-1113	11×13	16	18.5	7.2	8.7	11	214	80
NM2-1214	12×14	17.5	20	7.7	9.7	12	225	95
NM2-1315	13×15	18.5	21.5	8.7	10.2	13	235	115
NM2-1417	14×17	20	24.5	9.7	11.2	13.5	245	135
NM2-1618	16×18	23	26	10.7	11.7	15	265	180
NM2-1719	17×19	24.5	27	11.2	12.2	16	284	210

Packing unit 5

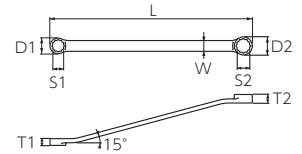

FLAT TYPE BOX END WRENCH SET (SHORT) [6pcs.]

6 pcs.

12pt.



No.	Weight(g)
NTM1506	300

Set contents	NM1S-0708,0810,1012,1113,1214,1417
--------------	------------------------------------

- Includes plastic tray (W265×D145×H35).
  - \* Resin trays do not fit into NEKB-1 and EKB-1 (metal case).
- Packing unit 1

FLAT TYPE BOX END WRENCH (SHORT)

12pt.



No.	S1×S2	D1	D2	T1	T2	W	L	Weight(g)
NM1S-0708	7×8	11.5	13	4.5	5	7.5	95	20
NM1S-0810	8×10	13	15.5	5	6	8.5	105	30
NM1S-1012	10×12	15.5	18	6	7	10	125	40
NM1S-1113	11×13	16.5	19	6.5	7.5	11	135	50
NM1S-1214	12×14	18	21	7	8	12	145	65
NM1S-1315	13×15	19.5	22.5	7.5	8.5	13	155	70
NM1S-1417	14×17	21	25	8	8.5	13.5	165	90

Packing unit 5

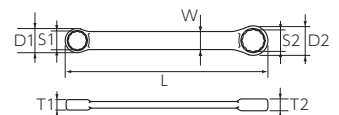

· Do not hit or extend it with a pipe or other tools.

FLAT TYPE BOX END WRENCH SET [6pcs.]

6 pcs.

12pt.



No.	Weight(kg)
NTM106	1

Set contents	
Flat type box end wrench	NM1-0810,1012,1214,1417,1719,2224

- Includes plastic tray (W445×D185×H35).
  - The bore is angled at 7° 30' and can be worked in a range of 15° by using the back and front side of the wrench, improving workability in tight spaces.
  - \* Resin trays do not fit into NEKB-2 and EKB-2 (metal case).
- Packing unit 1

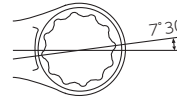

\* Only the straight standard Box end wrench has the angle fixed at 7° 30'.

FLAT TYPE BOX END WRENCH

12pt.



No.	S1×S2	D1	D2	T1	T2	W	L	Weight(g)
NM1-0810	8×10	13	15.5	5	6	8.5	180	40
NM1-1012	10×12	15.5	18	6	7	10	205	70
NM1-1214	12×14	18	21	7	8	12	225	100
NM1-1315	13×15	19.5	22.5	7.5	8.5	13	235	120
NM1-1417	14×17	21	25	8	8.5	13.5	245	140
NM1-1618	16×18	23.5	27	8.5	9	15	265	170
NM1-1719	17×19	25	27.5	8.5	9	16	284	210
NM1-2224	22×24	32	34.5	9.5	10	20	335	360

Packing unit 5

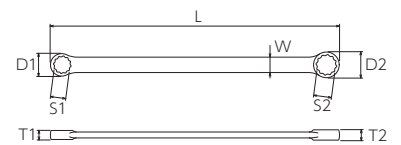

FLAT TYPE BOX END WRENCH SET [6pcs.]

6 pcs.

6pt.



No.	Weight(kg)
NTM106H	1

Set contents	
Straight standard Box end wrench (hex)	NM1-0810H,1012H,1214H,1417H,1719H,2224H

- Includes plastic tray (W445×D185×H35).
  - The bore is angled at 15° and can be worked in a range of 30° by using the back and front side of the wrench, improving workability in tight spaces.
  - \* Resin trays do not fit into NEKB-2 and EKB-2 (metal case).
- Packing unit 1

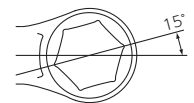

FLAT TYPE BOX END WRENCH

6pt.



No.	S1×S2	D1	D2	T1	T2	W	L	Weight(g)
NM1-0810H	8×10	13	15.5	5	6	8.5	180	40
NM1-1012H	10×12	15.5	18	6	7	10	205	70
NM1-1214H	12×14	18	21	7	8	12	225	100
NM1-1315H	13×15	19.5	22.5	7.5	8.5	13	235	120
NM1-1417H	14×17	21	25	8	8.5	13.5	245	140
NM1-1618H	16×18	23.5	27	8.5	9.5	15	265	170
NM1-1719H	17×19	25	27.5	8.5	9	16	284	210
NM1-2224H	22×24	32	34.5	9.5	10	20	335	360

Packing unit 5

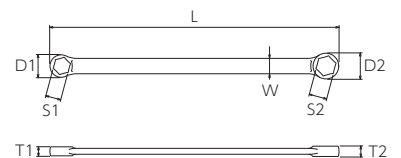

• Function mark is indicated under the product name. For the details, please refer to P.004-005.  
 • Products marked with should be ordered after checking stock.



**FLAT TYPE BOX END WRENCH SET (EXTRA LONG) [6pcs.]**

6 pcs.

12pt.



No.	Weight(kg)
NTM11L06	1.4

Set contents  
Flat type box end wrench (extra long) NM11L-0810,1012,1214,1417,1719,2224

- Includes plastic tray (W445×D185×H35).
- The protruding shape of one side makes it convenient for offset bolts such as belt pulleys.
- \* Resin trays do not fit into NEKB-2 and EKB-2 (metal case).

Packing unit 1

**FLAT TYPE BOX END WRENCH (EXTRA LONG)**

12pt.



No.	S1×S2	D1	D2	T1	T2	W	L	Weight(g)
NM11L-0810	8×10	11.8	14.3	7	8	9	233	65
NM11L-1012	10×12	14.3	17	8.5	9.5	11	290.5	95
NM11L-1214	12×14	17	19.5	10	11	13	328	140
NM11L-1315	13×15	18.5	21	10.8	11.8	14	349.7	190
NM11L-1417	14×17	19.5	23.2	11.5	13.2	15.5	367.2	200
NM11L-1618	16×18	22.5	24.5	12.9	13.9	16	388.5	290
NM11L-1719	17×19	23.2	26	14	15	17	404.6	340
NM11L-2224	22×24	30	33	16.5	18	21	431.5	510

Packing unit 5

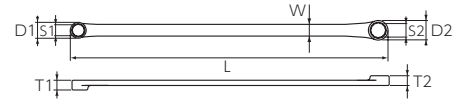

**S-SHAPED BOX END WRENCH SET [4pcs.]**

4 pcs.

12pt.



No.	Weight(g)
NTM1204	250

Set contents  
S-Shaped box end wrench NM12-08,10,12,14

- Includes plastic tray (W265×D145×H35).
- One piece is the same size and has different curvatures.
- The bolt/nut can be approached from four directions (left, right, back, and front).
- The aperture has a power-fit shape for ideal surface contact.
- \* Resin trays do not fit into NEKB-1 and EKB-1 (metal case).

Packing unit 1

**S-SHAPED BOX END WRENCH**

12pt.



No.	S	D	T	L	R1	R2	Weight(g)
NM12-08	8	13	5	115	7.8	32	30
NM12-10	10	15.5	6	135	8.8	39	50
NM12-11	11	16.5	6.5	145	9.7	41.5	60
NM12-12	12	18	7	155	10	44	70
NM12-13	13	19.5	7.5	165	10.7	47	80
NM12-14	14	21	8	175	10.9	49.5	100
NM12-15	15	22.5	8.5	185	11.2	52	120
NM12-16	16	23.5	8.5	195	12.1	55	130
NM12-17	17	25	8.5	205	12.8	57.5	150
NM12-18	18	27	9	215	13.2	60	170
NM12-19	19	27.5	9	225	13.9	62.5	200

Packing unit 5

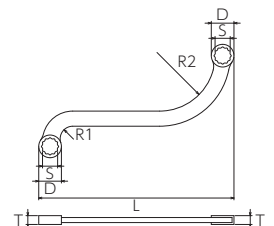

· Do not hit or extend it with a pipe or other tools.

HALF-MOON BOX END WRENCH SET [4pcs.]

4 pcs.



POWERFIT



No.	Weight(g)
NTMH204	400

Set contents	
Half moon wrench	NMH2-0810,1012,1214,1417

- Includes plastic tray (W265×D145×H35).
  - The thickness of the head is one of the smallest in the world, and it is more powerful in tight spaces.
  - The aperture has a power-fit shape for ideal surface contact.
  - Unique shape with different radii on the left and right sides. When held as a set, the same size can be used in different radii, expanding the working range.
  - Useful for tightening and loosening the triangular flange of mufflers and undercarriage bolts.
  - \* Resin trays do not fit into NEKB-1 and EKB-1 (metal case).
- Packing unit 1

HALF-MOON BOX END WRENCH



POWERFIT



No.	S1×S2	D1	D2	T1	T2	R1	R2	L	Weight(g)
NMH2-0810	8×10	13	15.5	4.6	5.6	30	70	125	40
NMH2-1012	10×12	15.5	18	5.6	6.6	35	80	150	70
NMH2-1214	12×14	18	21	6.6	7.6	40	90	170	100
NMH2-1315	13×15	19.5	22.5	7.5	8.5	43	90	182	110
NMH2-1417	14×17	21	25	7.6	8.1	45	105	195	140
NMH2-1618	16×18	23.5	27	8.5	9.5	50	120	225	180

Packing unit 5

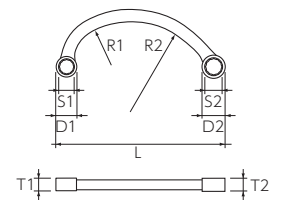

OPEN END WRENCH SET [6pcs.]

6 pcs.



No.	Weight(g)
NTS206	400

Set contents	
Open end wrench	NS2-05507,0810,1012,1113,1214,1417

- Includes plastic tray (W265×D145×H35).
  - The tip is designed to prevent opening by reinforcing the areas where stress is concentrated.
  - \* Resin trays do not fit into NEKB-1 and EKB-1 (metal case).
- Packing unit 1

OPEN END WRENCH



No.	S1×S2	D1	D2	T	L	Weight(g)
NS2-05507	5.5× 7	12	15	3.5	100	20
NS2-0607	6 × 7	12	15	3.5	100	20
NS2-0809	8 × 9	17	19	4.5	115	28
NS2-0810	8 ×10	17	21	4.5	120	30
NS2-1012	10 ×12	21	25	5.5	135	50
NS2-1113	11 ×13	23	27	6	145	70
NS2-1214	12 ×14	25	29	6.5	155	80
NS2-1315	13 ×15	27	31	7	162	91
NS2-1417	14 ×17	29	35	7	170	110
NS2-1618	16 ×18	33	37	8	185	139
NS2-1719	17 ×19	35	39	7.5	192	150
NS2-1921	19 ×21	39	43	8.5	215	195
NS2-2224	22 ×24	45	49	9.5	240	270
NS2-2832	28 ×32	57	65	12	280	515

Packing unit 5

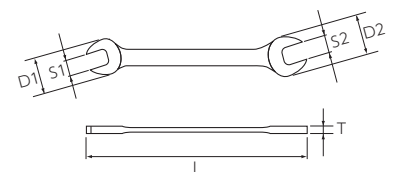

• Function mark is indicated under the product name. For the details, please refer to P.004-005.  
 • Products marked with should be ordered after checking stock.





OPEN END WRENCH SET (ANGLE HEAD)

[6pcs.]

6 pcs.



No.	Weight(g)
NTS306	440
Set contents	
Open end wrench (angle head)	NS3-08,10,12,13,14,17

- Includes plastic tray (W265×D145×H35).
  - Different angle angles (30°, 60°) in the same size are used for one wrench. Two different angle angles from the standard wrench (15°) provide a wider working range.
  - The tip is designed to prevent opening by reinforcing the areas where stress is concentrated.
  - \* Resin trays do not fit into NEKB-1 and EKB-1 (metal case).
- Packing unit 1

OPEN END WRENCH (ANGLE HEAD)



No.	S	D	T	L	Weight(g)
NS3-08	8	17	4	114	25
NS3-09	9	19	4.5	121	32
NS3-10	10	21	4.5	129	38
NS3-11	11	23	5	141	50
NS3-12	12	25	5.5	153	62
NS3-13	13	27	6	160	76
NS3-14	14	29	6.5	167	91
NS3-15	15	31	7	175	108
NS3-16	16	33	7	182	120
NS3-17	17	35	7.5	190	143
NS3-18	18	37	8	202	166
NS3-19	19	39	8.5	209	192

Packing unit 5

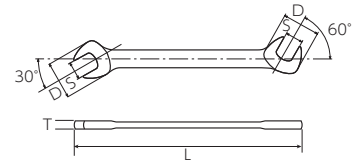

BRAKE PIPE WRENCH



POWERFIT



No.	S(6pt.)	D1	D2	T1	T2	L	Weight(g)
NMSZ-10	10	18	21.5	8.5	7	147	60

- Compact design with an overall length of 147 mm in consideration of tightening torque and working environment.
- Packing unit 5

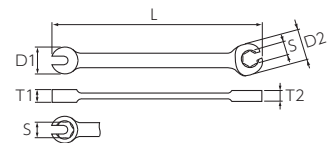

COMBINATION WRENCH SET [6pcs.]

6 pcs.



POWERFIT



No.	Weight(g)
NTMS206	500
Set contents	
Combination wrenches	NMS2-08,10,12,13,14,17

- Includes plastic tray (W265×D145×H35).
  - The wrench has a new design that prevents opening by hard strength, while the glasses part has a compact outer diameter and a power fit, each of which inherits the advantages of the other.
  - The angle of rise of the glasses is set at 15° for ease of use.
  - \* Resin trays do not fit into NEKB-1 and EKB-1 (metal case).
- Packing unit 1

• Do not hit or extend it with a pipe or other tools.

COMBINATION WRENCH SET [12pcs.]

12 pcs.



POWERFIT



No.	Weight(kg)
NTMS212	1.8

Set contents	
Combination wrenches	NMS2-055,07,08,10,12,13,14,17,19,21,22,24

- Includes plastic tray (W445×D185×H35).
  - The open end wrench part has a new design that reinforcing the areas where stress is concentrated. The end wrench part has a compact outer which inherits the advantages of the previous one.
  - The angle of rise of the glasses is set at 15° for ease of use.
  - \* Resin trays do not fit into NEKB-2 and EKB-2 (metal case).
- Packing unit 1

COMBINATION WRENCH



POWERFIT



No.	S	D1	D2	T1	T2	L	Weight(g)
NMS2-055	5.5	12	9	3	4.2	95	15
NMS2-06	6	12	9	3	4.5	95.5	15
NMS2-07	7	15	11	3.5	4.7	110	20
NMS2-08	8	17	12	4	5.5	125	30
NMS2-09	9	19	13.5	4.5	5.7	135	35
NMS2-10	10	21	14.5	4.5	6.2	150	50
NMS2-11	11	23	16.5	5	6.2	160	60
NMS2-12	12	25	17.5	5.5	6.7	170	70
NMS2-13	13	27	18.5	6	7.7	180	90
NMS2-14	14	29	20	6.5	8.7	190	100
NMS2-15	15	31	21.5	7	9.2	200	120
NMS2-16	16	33	23	7	9.2	215	135
NMS2-17	17	35	24.5	7.5	9.7	225	165
NMS2-18	18	37	26	8	10.7	240	190
NMS2-19	19	39	27	8.5	10.7	255	235
NMS2-20	20	41	28.5	8.5	11.7	269	235
NMS2-21	21	43	30	8.5	12.2	288	265
NMS2-22	22	45	31.5	9	12.7	303	300
NMS2-23	23	47	33	9	14.2	310	335
NMS2-24	24	49	34	9.5	14.7	335	365
NMS2-27	27	55	38	10.5	16.5	370	536
NMS2-30	30	61	42.5	11.5	18	410.5	696
NMS2-32	32	65	45	12	18	430	831

Packing unit 5

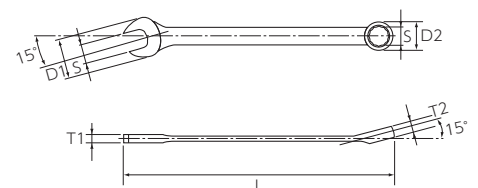

COMBINATION WRENCH SET [6pcs.]

inch

6 pcs.



POWERFIT



No.	Weight(g)
NTMS206B	500

Set contents	
Combination wrenches	NMS2-5/16,3/8,7/16,1/2,9/16,11/16

- Includes plastic tray (W265×D145×H35).
  - The open end wrench part has a new design that reinforcing the areas where stress is concentrated. The end wrench part has a compact outer which inherits the advantages of the previous one.
  - The angle of rise of the glasses is set at 15° for ease of use.
  - \* Resin trays do not fit into NEKB-1 and EKB-1 (metal case).
- Packing unit 1

• Function mark is indicated under the product name. For the details, please refer to P.004-005.  
 • Products marked with should be ordered after checking stock.



COMBINATION WRENCH

inch



12pt. POWERFIT

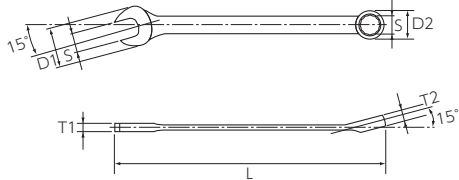

No.	S(in)	D1	D2	T1	T2	L	Weight(g)
NMS2-1/4	1/4	14	10.5	3.5	4.7	105	20
NMS2-5/16	5/16	17	12	4	5.2	125	30
NMS2-11/32	11/32	19	13.5	4.5	5.7	135	35
NMS2-3/8	3/8	20	14	4.5	6.2	145	45
NMS2-7/16	7/16	23	16.5	5	6.2	160	60
NMS2-1/2	1/2	27	18.5	6	7.7	180	90
NMS2-9/16	9/16	29	20	6.5	8.7	190	100
NMS2-5/8	5/8	33	23	7	9.2	215	135
NMS2-11/16	11/16	36	25	7.5	9.7	235	190
NMS2-3/4	3/4	39	27	8.5	10.7	255	235
NMS2-13/16	13/16	43	30	8.5	12.2	288	265
NMS2-7/8	7/8	45	31.5	9	12.7	303	300
NMS2-15/16	15/16	49	34	9.5	14.7	335	360
NMS2-1	1	52	35.5	10	15.2	350	400

Packing unit 5

nepros

WRENCHES

COMBINATION WRENCH (LONG)



12pt. POWERFIT

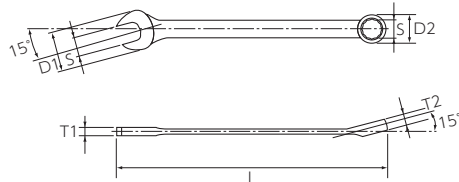

No.	S	D1	D2	T1	T2	L	Weight(g)
NMS2L-08	8	17	12	4	5.2	150	32
NMS2L-10	10	21	14.5	4.5	6.2	170	54
NMS2L-12	12	25	17.5	5.5	6.7	200	80
NMS2L-13	13	27	18.5	6	7.7	205	87
NMS2L-14	14	29	20	6.5	8.7	220	107
NMS2L-16	16	33	23	7	9.2	250	154
NMS2L-17	17	35	24.5	7.5	9.7	265	185
NMS2L-19	19	39	27	8.5	10.7	290	232
NMS2L-21	21	43	30	8.5	12.2	325	292
NMS2L-22	22	45	31.5	9	12.7	340	336
NMS2L-24	24	49	34	9.5	14.7	375	380
NMS2L-27	27	55	38	10.5	16.5	405	550

Packing unit 5

COMBINATION WRENCH (LONG)

inch



12pt. POWERFIT

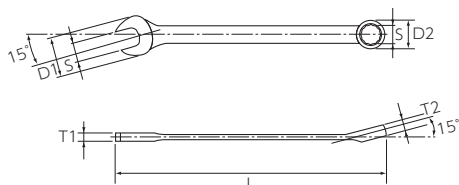
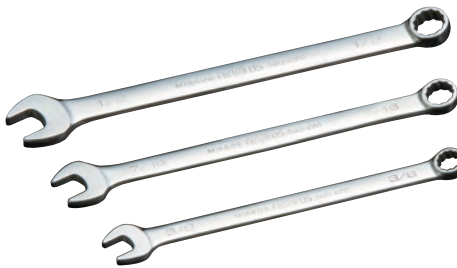

No.	S(in)	D1	D2	T1	T2	L	Weight(g)
NMS2L-1/4	1/4	14	10.5	3.5	4.7	130	25
NMS2L-5/16	5/16	17	12	4	5.2	150	35
NMS2L-11/32	11/32	19	13.5	4.5	5.7	155	40
NMS2L-3/8	3/8	20	14	4.5	6.2	165	50
NMS2L-7/16	7/16	23	16.5	5	6.2	185	70
NMS2L-1/2	1/2	27	18.5	6	7.7	205	100
NMS2L-9/16	9/16	29	20	6.5	8.7	220	115
NMS2L-5/8	5/8	33	23	7	9.2	250	155
NMS2L-11/16	11/16	36	25	7.5	9.7	270	210
NMS2L-3/4	3/4	39	27	8.5	10.7	290	260
NMS2L-13/16	13/16	43	30	8.5	12.2	325	295
NMS2L-7/8	7/8	45	31.5	9	12.7	340	330
NMS2L-15/16	15/16	49	34	9.5	14.7	375	400
NMS2L-1	1	52	35.5	10	15.2	390	470

Packing unit 5

• Do not hit or extend it with a pipe or other tools.

COMBINATION WRENCH SET (SHORT) [6pcs.]

6 pcs.

12pt.

POWERFIT



No.	Weight(g)
NTMS2S06	400
Set contents	
Short combination wrench	NMS2S-08,10,12,13,14,17

- Includes plastic tray (W265×D145×H35).
  - The open end wrench part has a new design that reinforcing the areas where stress is concentrated. The end wrench part has a compact outer which inherits the advantages of the previous one.
  - The angle of rise of the glasses is set at 15° for ease of use.
  - \* Resin trays do not fit into NEKB-1 and EKB-1 (metal case).
- Packing unit 1

COMBINATION WRENCH (SHORT)

12pt.

POWERFIT



No.	S	D1	D2	T1	T2	L	Weight(g)
NMS2S-08	8	17	12	4	5.2	90	20
NMS2S-10	10	21	14.5	4.5	6.2	110	35
NMS2S-12	12	25	17.5	5.5	6.7	125	50
NMS2S-13	13	27	18.5	6	7.7	135	65
NMS2S-14	14	29	20	6.5	8.7	140	70
NMS2S-17	17	35	24.5	7.5	9.7	165	120

Packing unit 5

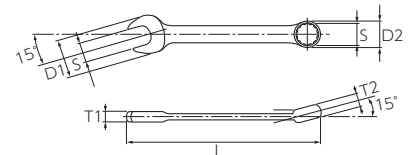

ADJUSTABLE WRENCH



No.	size	D (maximum aperture)	T1	T2	L	Weight(g)
NWM-250	250	29	9.5	14.5	255	510

- The 15° design is designed for ease of use.
  - Extra-thick, well-balanced grip that is easy on the hand.
  - Easy-to-read two-side width dimension scale.
- Packing unit 5

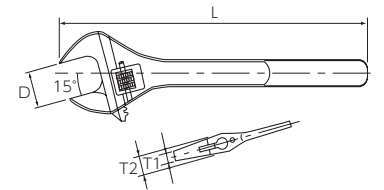

T-SHAPED WRENCH

6pt.

POWERFIT



No.	S(6pt.)	D	d	ℓ	L	Weight(g)
NHT-08	8	11.5	8	150	256	220
NHT-10	10	14	8	160	256	230
NHT-12	12	16.5	9	180	257	340
NHT-14	14	19	10	200	257.5	430

- Weights are placed at both ends of the handle to improve balance when turning quickly and to enhance workability.
  - The aperture section is equipped with a magnet.
  - The diameter is thinner than that of conventional products, which improves workability.
  - \* Repair parts are available. Please contact our distributors for details.
- Packing unit 5

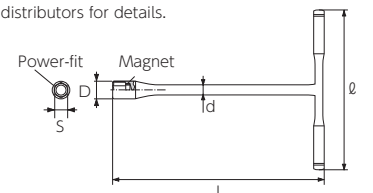

• Function mark is indicated under the product name. For the details, please refer to P.004-005.  
 • Products marked with should be ordered after checking stock.



nepros

---

## PLIERS



PLIERS SET [3pcs.]

3 pcs.



No.	Weight(g)	
NTP03	800	
Set contents		
Pliers	NPJ-200	
Longnose pliers	NPSL-200	
Wide Nippers	NPN-150BW	

· Includes plastic tray (W265×D145×H35).  
 \* Resin trays do not fit into NEKB-1 and EKB-1 (metal case).  
 Packing unit 1

COMBINATION PLIERS



No.	size	B1	B2	T1	T2	L	Weight(g)
NPJ-150	150	29	44.5	9.5	17	160	200
NPJ-200	200	33	54	10	17	204	305

· The soft grip is easy to grip and gentle on the hand.  
 · The pinching portion is a two-stage shape that easily grips both thin and thick objects.  
 · The grip end does not close completely to prevent hands from being caught in the grip.  
 Packing unit 5

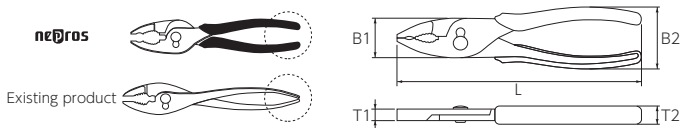

DIAGONAL CUTTING PLIERS



No.	size	B1	B2	T1	T2	L	Weight(g)
NPN-150	150	19	55.5	11	18	150	180

· The large fulcrum point reduces rattling.  
 · The blade is strengthened by high-frequency secondary quenching.  
 · The soft grip is designed to reduce pain when gripped tightly.  
 \* This product is not plated because of the cutting blade. Please take care of it by applying oil, etc.  
 Packing unit 5

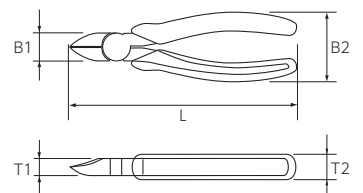

WIDE DIAGONAL CUTTING PLIERS



No.	size	B1	B2	T1	T2	L	Weight(g)
NPN-150BW	150	25	54	10	17	160	200

· The large fulcrum point reduces rattling.  
 · The blade is strengthened by high-frequency secondary quenching.  
 · The soft grip is designed to reduce pain when gripped tightly.  
 \* This product is not plated because of the cutting blade. Please take care of it by applying oil, etc.  
 Packing unit 5

Cutting ability  
 Hard wire –  $\phi 1.8$   
 Soft wire –  $\phi 2.3$

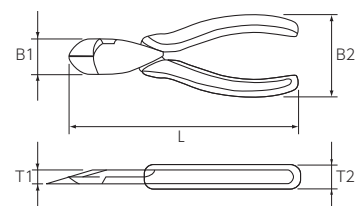

· Function mark is indicated under the product name. For the details, please refer to P.004-005.  
 · Products marked with should be ordered after checking stock.



**LONG NOSE PLIERS**



No.	size	B1	B2	T1	T2	L	Weight(g)
NPSL-150	150	17	55.5	10	17	164	150

- The large fulcrum and precision machining technology reduce rattling and improve tip engagement accuracy.
  - The soft grip is designed to reduce pain when gripped tightly.
  - \* This product is not plated because of the cutting blade. Please take care of it by applying oil, etc.
- Packing unit 5

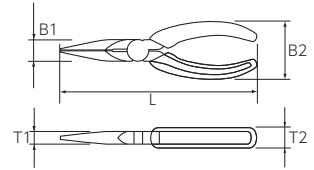

**LONG NOSE PLIERS**



No.	size	B1	B2	T1	T2	L	Weight(g)
NPSL-200	200	19	54	10	17	205	215

- The large fulcrum and precision machining technology reduce rattling and improve tip engagement accuracy.
  - The soft grip is designed to reduce pain when gripped tightly.
  - \* This product is not plated. Please apply oil or other care to this product.
  - \* This product does not have a cutting blade.
- Packing unit 5

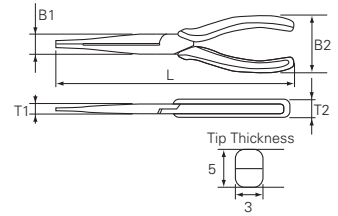
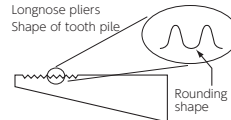

**ANGLE NOSE PLIERS**



No.	size	B1	B2	T1	T2	L	Weight(g)
NPSL-200BN	200	19	54	10	17	176	215

- The large fulcrum and precision machining technology reduce rattling and improve tip engagement accuracy.
  - The soft grip is designed to reduce pain when gripped tightly.
  - The 60° angle is very convenient for attaching and detaching hose bands.
  - \* This product is not plated. Please apply oil or other care to this product.
  - \* This product does not have a cutting blade.
- Packing unit 5

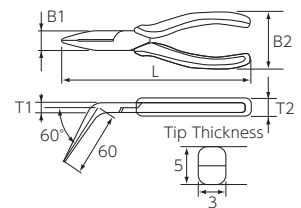

• Do not use it as a hammer.

nepros

---

# SCREWDRIVERS

WOODEN GRIP SCREWDRIVER SET [6pcs.]

6 pcs.



No.	Weight(kg)	
NTD306	1.1	
Set contents		
Wooden grip screwdriver (stubby cross)	ND3P-1,2,3	
Wooden grip screwdriver (stubby flat)	ND3M-055,06,08	

- Includes plastic tray (W445×D185×H35).
  - The grip is streamlined and has an unprecedentedly beautiful and original form.
  - The tip has a magnet.
  - Crosses are finished in red and flat are finished in green, making them easy to distinguish and improving workability.
  - Considering the use of cross and flat, original chromium vanadium steel materials with different hardness are used for each.
  - The tip with the smallest possible gap between the screw and the tip is resistant to tampering and transmits torque reliably.
- \* Resin trays do not fit into NEKB-2 and EKB-2 (metal case).  
Packing unit 1

WOODEN GRIP SCREWDRIVER



No.	size	d	D	S	ℓ	L	Weight(g)
ND3P-1	No.1	5.5	31	8	75	191	110
ND3P-2	No.2	6.3	35	10	100	228	160
ND3P-3	No.3	8	36	12	150	291	240

Packing unit 5

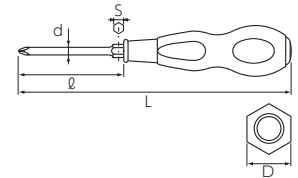

WOODEN GRIP SCREWDRIVER



No.	a	b	d	D	S	ℓ	L	Weight(g)
ND3M-055	0.8	5.5	5.5	31	8	75	191	110
ND3M-06	1.0	6.3	6.3	35	10	100	228	160
ND3M-08	1.2	8.0	8.0	36	12	150	291	240

Packing unit 5

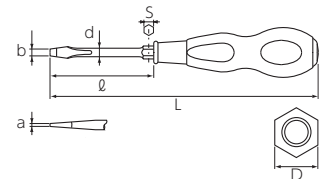

WOODEN GRIP SCREWDRIVER (STUBBY)



No.	size	a	b	d	D	ℓ	L	Weight(g)
ND3PS-2	Cross No. 2	—	—	6	36	28	81	40
ND3MS-06	Flat	1.0	6.3	6	36	28	81	40

Packing unit 5

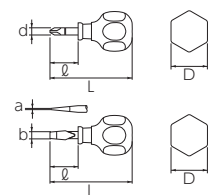

· Do not hit or pry.

SCREWDRIVER SET [6pcs.]



No.	Weight(kg)	
NTD106	1	

Set contents	
Screwdriver (cross)	ND1P2-2,3
Screwdriver (flat)	ND1M2-6,8
Stubby driver (cross)	ND1PS-2
Stubby screwdriver (flat)	ND1MS-6

- Includes plastic tray (W265×D145×H35).
  - The grip is rectangular for easy fast turning.
  - The double-layered grip creates a better fit.
  - The tip has a magnet.
  - The shaft is a through-through type and the grip end has a washer (except for stubby screwdrivers).
  - The tip with the smallest possible gap between the screw and the tip is resistant to tampering and transmits torque reliably.
  - \* Resin trays do not fit into NEKB-1 and EKB-1 (metal case).
- Packing unit 1

SCREWDRIVER SET [4pcs.]



No.	Weight(g)	
NTD1P04	600	

Set contents	
Screwdriver (cross)	ND1P2-1,2,3
Stubby driver (cross)	ND1PS-2

- Includes plastic tray (W265×D145×H35).
  - \* Resin trays do not fit into NEKB-1 and EKB-1 (metal case).
- Packing unit 1

SCREWDRIVER SET [4pcs.]



No.	Weight(g)	
NTD1M04	600	

Set contents	
Screwdriver (flat)	ND1M2-5,6,8
Stubby screwdriver (flat)	ND1MS-6

- Includes plastic tray (W265×D145×H35).
  - \* Resin trays do not fit into NEKB-1 and EKB-1 (metal case).
- Packing unit 1

SCREWDRIVER



No.	size	d	D	S	ℓ	L	Weight(g)
ND1P2-1	No.1	5.5	32	8	70	178	120
ND1P2-2	No.2	6.3	33	10	95	213	180
ND1P2-3	No.3	8	35	12	145	273	260

Packing unit 5

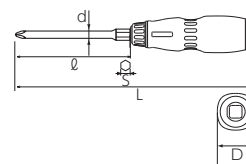

· Function mark is indicated under the product name. For the details, please refer to P.004-005.  
 · Products marked with ⚡ should be ordered after checking stock.





SCREWDRIVER



Flat



No.	a	b	d	D	S	ℓ	L	Weight(g)
ND1M2-5	0.8	5.5	5.5	32	8	70	178	120
ND1M2-6	1.0	6.3	6.3	33	10	95	213	180
ND1M2-8	1.2	8	8	35	12	145	273	260

Packing unit 5

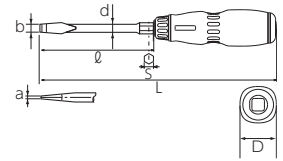

SCREWDRIVER (STUBBY)



Cross



Flat



No.	size	a	b	d	D	ℓ	L	Weight(g)
ND1PS-2	Cross No. 2	—	—	6.3	35	25	70	60
ND1MS-6	Flat	1.0	6.3	6.3	35	25	70	60

- The tip has a magnet.
- The grip end is equipped with a tip indicator emblem so that the tip shape can be recognized at a glance.

Packing unit 5

